

日本陸軍

U 15
U635
no. 27
c. 3

關スル

27

UNCLASSIFIED

47-21804

軍人
案内書



RECEIVED
PEN
APR 11 1952
1

UNCLASSIFIED

LIBRARY
US ARMY WAR COLLEGE
FORT MONMOUTH BARRACKS, P.

UNCLASSIFIED

GRADED _____ BY AUTHORITY

OF E.O. 10501

BY BAKERS ON 12 Aug 87

DISTRIBUTION:

Armies (5); Corps (5); T of Opns (200); Base Comds (5); Island Comds (5); Def Comd (5); Depts (5); HD (5); Sectors (5); Sub Sectors (5); USAF (overseas & Canada) (5); Sp Trps (AGF) (5); PE (5); Posts, Camps, Sta (1).

D (5); B (5); R (5); Bn (5); C (5) except 7 (15);

IC 1, 5, 6, 17, 18 (10)

IC 1: T/O & E 1-27; 1-228

Comb Units MT; Comb Camera Units MT Sp; Comb Unit A; Comb Camera Units; Ftr Control Det SP

IC 5: T/O & E 5-17; 5-217; 5-227; 5-228; 5-457; 5-476T; 5-477T; 5-500; Comb Co. Engr.

IC 6: T/O & E 6-26; 6-27; 6-37; 6-57; 6-67; 6-127; 6-157; 6-167 6-177; 6-197; 6-217; 6-218; 6-227;



6-225; 6-277T; 6-327; 6-337; 6-357; 6-367; 6-397; 6-527; 6-537.

IC 17: T/O & E 17-17; 17-18; 17-27; 17-47S; 17-57; 17-58; 17-98S.

IC 18: T/O & E 18-27; 18-37; 18-51

For explanation of symbols, see FM 21-6.

LIBRARY

US ARMY WAR COLLEGE
CARI LEIF BARRACKS DA

~~RESTRICTED~~

MILITARY INTELLIGENCE SERVICE

SPECIAL SERIES

WAR DEPARTMENT

NO. 27

WASHINGTON 25, D. C. 15 NOVEMBER 1944.

MID 461

SHARE THIS COPY!

This issue of *SPECIAL SERIES* has been prepared especially for the soldier. Although there are not enough copies to provide for every man, it is possible for every soldier to read the *GUIDE*. *PLEASE PASS THIS COPY AROUND.*

Distribution of this publication is based on one copy for each squad in the Arms and one for each platoon in the Services, and all commands are requested to enforce this distribution. Requests for additional copies should be made through channels to the appropriate agency of The Adjutant General.

Reproduction of the material in the *GUIDE* is encouraged, provided the classification is maintained and a copy of the reproduced material is forwarded to the Military Intelligence Service, War Department, Washington 25, D. C.

~~RESTRICTED~~

SPECIAL SERIES NO. 27

U. S. Army Military History Institute

~~RESTRICTED~~

15 NOVEMBER 1944

477
**SOLDIER'S GUIDE
TO THE JAPANESE ARMY,**



MILITARY INTELLIGENCE SERVICE

U.S. WAR DEPARTMENT • WASHINGTON, D. C.

6... Staff, G...
PROPERTY OF US ARMY

U
15
2635
no. 27
c. 3

87162

ONE + 1301003

~~UA 347
2311~~

CONTENTS

	Page		Page
CHAPTER I. THE JAPANESE SOLDIER	1	Mortars	77
Entrance into the Army.....	1	Antitank and Infantry Guns	87
Characteristics and Training.....	5	CHAPTER IV. ARTILLERY AND ARMORED MA-	
Promotion of Morale.....	7	TERIEL	101
Conduct in Battle.....	11	Artillery	101
CHAPTER II. THE NECESSITIES OF LIFE	15	Armored Matériel	116
Army Supply.....	15	<i>Tankettes</i>	119
Rations.....	17	<i>Light Tanks</i>	119
Uniforms.....	21	<i>Medium Tanks</i>	119
Insignia.....	27	<i>Amphibious Tank</i>	130
Other Supplies.....	29	<i>Armored Cars</i>	130
Personal Equipment.....	34	CHAPTER V. ORGANIZATION OF THE JAPANESE	
CHAPTER III. INFANTRY WEAPONS	43	ARMY	131
Small Arms.....	45	The Infantry Division	131
<i>Pistols</i>	45	The Regiment and Lower Echelons	137
<i>Rifles</i>	49	<i>The Infantry Battalion</i>	140
<i>Grenade Launchers</i>	53	<i>The Infantry Rifle Company</i>	143
<i>Grenades</i>	53	CHAPTER VI. TACTICS: THE JAPANESE ARMY	
<i>Grenade Dischargers</i>	58	IN ACTION	146
<i>Machine Guns</i>	65		

	Page		Page
The Offensive.....	146	Jungle Warfare.....	163
<i>Meeting Engagements</i>	148	<i>Offensive</i>	163
<i>Attack of Position</i>	149	<i>Defensive</i>	167
<i>Night Attacks</i>	150	Artillery and Tank Tactics.....	168
<i>Pursuit</i>	152	<i>Artillery Tactics</i>	168
The Defensive.....	153	<i>Tank Tactics</i>	170
<i>Counterattacks</i>	154	Booby Traps and Mines.....	173
<i>Delaying Actions; Withdrawals</i>	155	<i>Booby Traps</i>	173
<i>Defensive Positions</i>	155	<i>Land Mines</i>	180

ILLUSTRATIONS

Figure	Page	Figure	Page
The Japanese Soldier.....	FRONTISPICE	11. Noncommissioned officers in M90 full field dress.....	24
1. Military instruction in Japanese high school.....	2	12. Enlisted man in M90 full field uniform.....	26
2. Aviation apprentice mechanics in training.....	4	13. Enlisted man in M90 uniform.....	26
3. Fencing practice.....	6	14. Enlisted man in M98 full field uniform.....	26
4. Artillery experience in China.....	8	15. Enlisted man in M98 overcoat.....	26
5. The principal Japanese decorations.....	10	16. M90 officer's field uniform.....	28
6. Officer wearing decorations.....	11	17. Officer in M98 uniform.....	28
7. Regimental colors.....	13	18. Japanese officers in Berlin.....	30
8. Chow line and cook stove.....	20	19. Officers in winter overcoats.....	31
9. Enlisted men in M98 uniform.....	22	20. Tropical loose shorts, lightweight uniform, tropical uniform.....	32
10. <i>Tabi</i>	23		

Figure	Page	Figure	Page
21. Packs from the rear.....	34	42. Model 100 (1940) grenade launcher.....	57
22. Front and rear views of packs for noncom- missioned officers and enlisted men; for officers..	35	43. Model 97 (1937) hand grenade.....	58
23. Canvas hold-all as a combat pack.....	36	44. Model 91 (1931) hand grenade.....	59
24. Mess kits for noncommissioned officers and en- listed men; for officers.....	37	45. Model 99 (1939) "Kiska" hand grenade.....	60
25. Canteens for noncommissioned officers and en- listed men; for officers.....	37	46. Left to right: Model 89 (1929) shell, Model 91 (1931) hand grenade, Model 97 (1937) hand grenade, Model 99 (1939) grenade.....	61
26. Troops in action showing field equipment.....	39	47. Stick grenade.....	62
27. Belt and ammunition pouches.....	40	48. Incendiary stick hand grenade.....	62
28. Gas mask in alert position.....	41	49. Prussic acid gas grenade.....	63
29. Jungle troops detrucking.....	42	50. Model 89 (1929) 50-mm grenade discharger.....	64
30. Model 26 (1893) 9-mm revolver.....	44	51. Model 10 (1921) 50-mm grenade discharger.....	64
31. Nambu 8-mm pistol.....	44	52. Model 11 (1922) 6.5-mm light machine gun.....	66
32. Model 14 (1925) 8-mm pistol.....	44	53. Feed hopper of Model 11 (1922) 6.5-mm light machine gun.....	67
33. Nambu 8-mm pistol and shoulderstock.....	46	54. Model 92 (1932) 7.7-mm Lewis-type light ma- chine gun.....	68
34. Nambu and Model 14 8-mm pistols.....	47	55. Model 96 (1936) 6.5-mm light machine gun.....	69
35. Model 94 (1934) 8-mm pistol, magazine and holster.....	48	56. Model 99 (1939) 7.7-mm light machine gun.....	70
36. Japanese rifles: Model 38 (1905) 6.5-mm rifle, Model 38 (1905) 6.5-mm carbine.....	50	57. Model 92 (1932) 7.7-mm heavy machine gun.....	71
37. Model 44 (1911) 6.5-mm cavalry carbine.....	51	58. Model 3 (1914) 6.5-mm heavy machine gun.....	73
38. Model 97 (1937) 6.5 mm sniper's rifle; Model 99 (1939) 7.7-mm rifle.....	52	59. Details of sights of Model 92 (1932) 7.7-mm heavy machine gun.....	74
39. Cup-type grenade launcher and grenade.....	54	60. Model 93 (1933) 13-mm heavy machine gun (single mount).....	76
40. Spigot-type grenade launcher.....	55	61. Model 93 (1933) 13-mm heavy machine gun (dual mount).....	77
41. Spigot-type grenade launcher, grenades, and carrying case.....	56	62. Model 98 (1938) 50-mm mortar and stick bomb..	78

Figure	Page
63. Model 11 (1922) 70-mm infantry mortar.....	80
64. Model 97 (1937) 81-mm mortar.....	81
65. Model 99 (1939) 81-mm mortar.....	82
66. Model 94 (1934) 90-mm mortar.....	83
67. Model 97 (1937) 90-mm mortar.....	84
68. Model 93 (1933) 150-mm mortar.....	86
69. Model 97 (1937) 20-mm antitank rifle.....	88
70. Model 97 (1937) 20-mm antitank rifle (right side).....	89
71. Model 98 (1938) 20-mm antiaircraft-antitank machine cannon.....	90
72. Two views of Model 11 (1922) 37-mm gun showing accessories.....	92
73. Model 94 (1934) 37-mm gun.....	94
74. Model 1 (1941) 47-mm gun.....	95
75. Model 92 (1932) 70-mm howitzer.....	96
76. Model 41 (1908) 75-mm mountain (infantry) gun.....	98
77. Model 38 (1905) 75-mm gun (improved).....	100
78. Model 88 (1928) 75-mm AA gun.....	102
79. Model 90 (1930) 75-mm gun.....	103
80. Model 94 (1934) 75-mm gun (mountain).....	104
81. Model 95 (1935) 75-mm gun.....	105
82. Model 91 (1931) 105-mm howitzer.....	108
83. Model 92 (1932) 105-mm gun.....	110
84. Model 14 (1925) 105-mm gun.....	112
85. Model 4 (1915) 150-mm howitzer.....	113
86. Model 96 (1936) 150-mm howitzer.....	114

Figure	Page
87. Model 92 (1932) tankette.....	117
88. Model 97 (1937) tankette.....	118
89. Model 93 (1933) light tank.....	120
90. Model 95 (1935) light tank.....	121
91. Model 89A (1929) medium tank.....	122
92. Model 94 (1934) medium tank.....	123
93. Model 97 (1937) medium tank (A) with 57-mm gun; with 47-mm gun (B).....	124, 125
94. Model 97 (1937) medium tank used as pillbox on Saipan.....	126
95. New type amphibious tank.....	127
96. M92 (1932) armored car.....	128
97. The standard infantry division.....	132
98. The strengthened infantry division.....	134
99. The standard infantry regiment.....	138, 139
100. The standard infantry battalion.....	141
101. The strengthened infantry battalion.....	142
102. Infantry rifle company strengthened—without heavy weapons platoon.....	144
103. Infantry rifle company strengthened—with heavy weapons platoon.....	145
104. Japanese all-around defense area.....	156
105. A well-built and concealed pillbox.....	157
106. Japanese machine-gun emplacement.....	158
107. Pillboxes used in defense of Torokina.....	159
108. Pillbox at Buna.....	160
109. Concrete pillbox on Guam.....	160

Figure	Page	Figure	Page
110. Cleverly concealed concrete pillbox under a Saipan building.....	161	119. Use of grenade in trip-wire booby traps.....	175
111. Steel pillbox on Tarawa.....	161	120. Use of grenades in booby trap.....	176
112. Entrance to pillbox on Tarawa.....	162	121. Electrical ignition booby trap.....	176
113. Embrasure of Japanese pillbox on Tarawa.....	163	122. Phonograph booby trap.....	178
114. Japanese bunkers.....	164	123. Tin-can-type booby trap.....	178
115. Parasol-type booby trap.....	172	124. Firing device for booby trap.....	179
116. Flashlight-type booby trap.....	172	125. Tape-measure mine.....	180
117. Pull-type hand grenade.....	173	126. Mushroom-type mine.....	180
118. Tube-type booby trap.....	174	127. Japanese magnetic mine.....	181
		128. Japanese anti-invasion mine.....	182

FRONT COVER: The Japanese characters on the cover read "Soldier's Guide to the Japanese Army".



CHAPTER I. THE JAPANESE SOLDIER

Lack of information is a most fertile source of exaggeration, distortion, and legend which, if unrefuted, eventually assume the stature of accepted fact. For years the Japanese were taken lightly as military antagonists, and the confidence of the Western World in its disdainful appraisal of their military and naval capabilities seemed justified by the Japanese failure to achieve decisive victory in the Chinese war. Then, following the outbreak of the war with the United States and Britain, a succession of speedy and apparently easy victories stimulated the rise of the legend of the invincibility of the Japanese soldier. He allegedly was unconquerable in jungle terrain; his fanatical, death-courting charges and last-ditch defenses were broadcast until popular repute invested the Japanese soldier with almost superhuman attributes.

Several years of combat experience against the Japanese have replaced such fanciful notions by more realistic evaluation. While the military capabilities of the Japanese soldier still are appreciated, it is now realized that he has pronounced weaknesses. As a sol-

dier his good qualities are not innate but are the result of careful training and preparation for specific tactical situations. Hence an accurate appraisal of the Japanese soldier must give adequate attention to the Japanese system of military training and show its effect on his physical, mental, and temperamental characteristics.

ENTRANCE INTO THE ARMY

All Japanese males between the ages of 17 and 45 are liable to call for compulsory military training and service. Those from 17 to 19 are not actually inducted into service but are given some training as part of the Second National Army, although they may volunteer for active service. It is reported that voluntary enlistments of 15-year-old boys now are accepted for service in mechanized, air, and signal units.

In examining youths of 19 for service, those at least 5 feet tall and in good physical condition are placed in Class A, while those just under the minimum height requirement and in good condition are put in



Figure 1. Military instruction in Japanese high school.

Class B-1. Both classes are considered fit for active duty and are inducted as the needs of the armed forces require. Those whose hearing or eyesight is somewhat deficient are put in classes B-2 and B-3 for assignment to the First or Second Conscript Reserve, depending upon their general physical condition. Those in Class C, considered fit for limited service, are placed in the Second National Army along with the boys of 17 to 19.

It is to be expected, of course, that as the manpower needs of the Japanese Army have become more urgent, the standards for acceptance for general service have been lowered. Koreans, who have been drafted into labor units since 1942, now are conscripted for military service, and it also is reported that conscription among the Formosans will be introduced. In recognition of the pressing need for skilled labor in industry, however, exemptions for technicians and key personnel now are granted.

Military indoctrination of Japanese boys begins in early childhood, and semimilitary instruction is given in the primary schools by the teachers when the pupils reach their eighth year. Compulsory military training is continued in part-time youth schools for

those who go into industrial employment after primary school. In middle and higher schools military instruction is given by army officers, and similar programs are conducted in colleges and universities. When Japanese conscripts reach induction age they have had a considerable amount of military training. In peacetime, conscripts underwent rigorous training for two years, progressing from section and platoon exercises to regimental maneuvers. Since the outbreak of the war the training period naturally has been curtailed. Army Apprentice Schools provide training in technical fields such as aviation, signal-equipment operation and maintenance, tanks, artillery, and ordnance. Primary school graduates from 14 to 15 years of age are accepted, and graduates of these apprentice schools provide a pool of trained technical personnel for the army.

Many officers of the Japanese Army are graduates of the Military Academy. Cadets were selected from graduates of the three-year courses at the Junior Military Schools. Besides these, enlisted men under 22 and noncommissioned officers under 25 were permitted to apply for admission, as well as candidates-at-large from 16 to 18 years of age. After two years

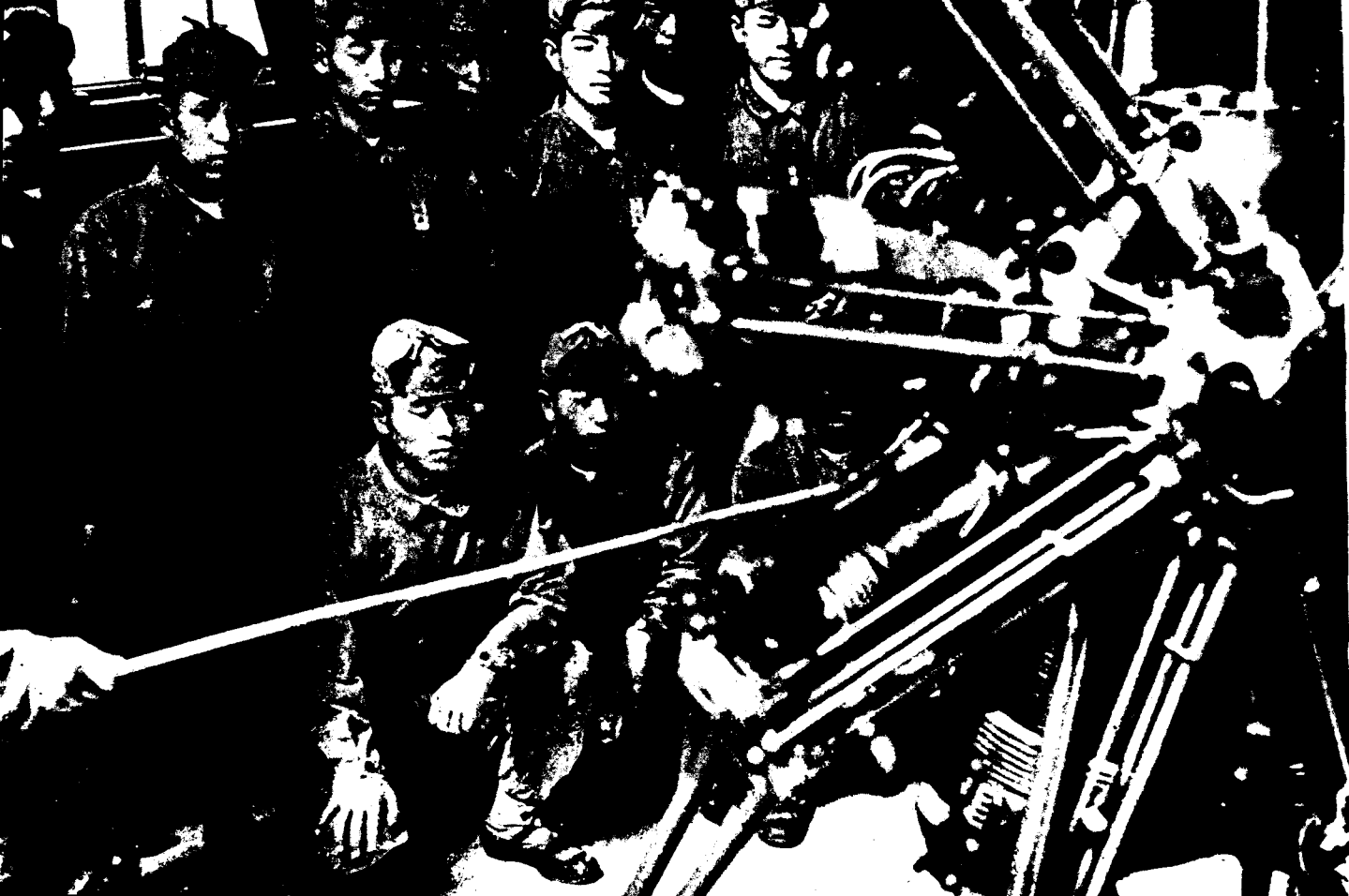

training in the preparatory school the cadets performed eight months duty with troops. This tour was followed by 18 months study at the Academy. After a four-month probationary period as sergeant majors the Academy graduates received their commissions.

There are four army districts in Japan, subdivided into division and regimental districts. Depot divisions in the division districts are responsible for the training of conscripts, as well as for the conduct of refresher courses for reservists and the activation and equipment of new divisions. Upon mobilization, the depot divisions add some reservists to raise their personnel to authorized strength if necessary and then go into the field as active divisions, leaving behind a cadre in their district. Or, on the other hand, a cadre of the depot division may serve as the nucleus for a new division, most of the complement of which is procured from reservists.

Replacements are provided for units in the field by the dispatch of the requisite number from the designated depot division. If a considerable number

are required in a theater, a field replacement unit may be sent into the theater to provide units with replacements as needed.

CHARACTERISTICS AND TRAINING

The Japanese soldier is small in stature in comparison with Americans. His average height is 5 feet 3½ inches; his weight, 116 to 120 pounds. His limbs are short and thick. Despite the reputation of the Japanese for quickness and agility, the average soldier even after rigorous training is apt to be awkward. His posture is faulty, and his normal gait shuffling. His teeth usually are poor and often are protruding. Although the average Japanese is cleanly in his personal habits, sanitation measures of Japanese troops in the field are inadequate according to Western standards.

Most Japanese soldiers are of peasant stock and have a background of hard work and privation. The physical hardihood of the soldier is enhanced by the most rigorous training which emphasizes physical condition, calisthenics, and wall-scaling. Arduous marches, which include much double time and uphill movement, eventually enable him to make extremely

Figure 2. Aviation apprentice mechanics in training (opposite page).



difficult marches with full pack under most trying conditions. Much marching and tactical training are done in adverse weather—in blistering heat or bitter cold—and there is much open-air bivouacking in rigorous climate. The training program also devotes great attention to fencing, Judo, and swimming, all of which enhance physical fitness and provide tactically valuable training.

Field exercises are as realistic as they are strenuous. Every effort is made to simulate the noise and confusion of battle; live ammunition is used, and casualties have occurred as the result of this realism. All infantrymen and engineers are taught sniping and scouting techniques, even though many will not be called upon to perform these duties in actual combat. There is much stress on night operations, and whenever possible the training program includes at least one night problem per week, with special attention to small-unit exercises. Many Japanese soldiers were sent to China for some actual combat experience before being sent into theaters where they met British or American forces.

Figure 3. Fencing practice (opposite page).

The training of the Japanese soldier also aims at the inculcation of qualities and ideals deemed necessary for military success. Recruits are admonished to cultivate unflagging alertness and readiness to checkmate the ruses and stratagems of the enemy. Resistance to the spread of rumors is stressed, and soldiers are exhorted to control their anger and suppress private grudges on the ground that military success depends to a great extent on harmonious relations within their unit. High standards of morality, according to training doctrine, must be maintained in the camp or on the battlefield.

PROMOTION OF MORALE

The Japanese soldier is urged to be quick to respond to the needs of his comrades-in-arms and willing to share his good fortune with them. Honesty is stressed as a necessary soldierly virtue, and exaggerations and lies are to be shunned as dishonorable. Good care of individual health is taught as a military virtue of the highest importance, and soldiers likewise are constantly reminded of the necessity of taking good care of horses and arms.

Decorations and awards are important in the Jap-



anese military system and are considered prime factors in the development and maintenance of high standards of individual and unit morale. The highest award is the Order of Golden Kite, which is open only to military personnel. Admission to the order is granted in recognition of conspicuous service against a foreign foe. There are seven classes of membership, with the highest one closed to enlisted men. In addition to the honor, inclusion in the order carries with it a life annuity.

The Order of the Rising Sun, membership in which also entails receipt of an annuity, is open both to civilian and military personnel who have performed meritorious service. There are eight classes, with only the two lowest available to enlisted men. Length of service and good conduct are recognized by inclusion in the Order of the Sacred Treasury which has eight classes, two of which are open to enlisted men.

Medals of three classes are awarded for distinguished, meritorious, and exceptional service respectively. To those whose services are "not inconsiderable" but not of sufficient distinction to justify

award of one of the three medals, monetary grants are made. Campaign and good conduct medals also are presented, and there are badges of proficiency in various technical skills. A Diploma of Merit may be bestowed on individuals or units for distinguished service in the face of the enemy, and badges are given to those wounded in action. Medals also are awarded the next of kin of those killed in action, or to service men who die within three years after contraction of disease in military service.

Decorations and awards up to the fifth class of the Order of the Golden Kite may be made in the field, after approval by the appropriate War Ministry Board. Officers receive their awards from their divisional commander; enlisted men, from their immediate unit commander. Decorations and medals are returned to the government after the death of their holders.

Despite precepts and the inducements of decorations and awards, major crimes and military offenses are not rare in the Japanese Army. Robbery, rape, and trespass are recurrent offenses, and there is little reason to believe that training has succeeded in materially curtailing desertion, destruction of mili-

Figure 4. Artillery experience in China (opposite page).

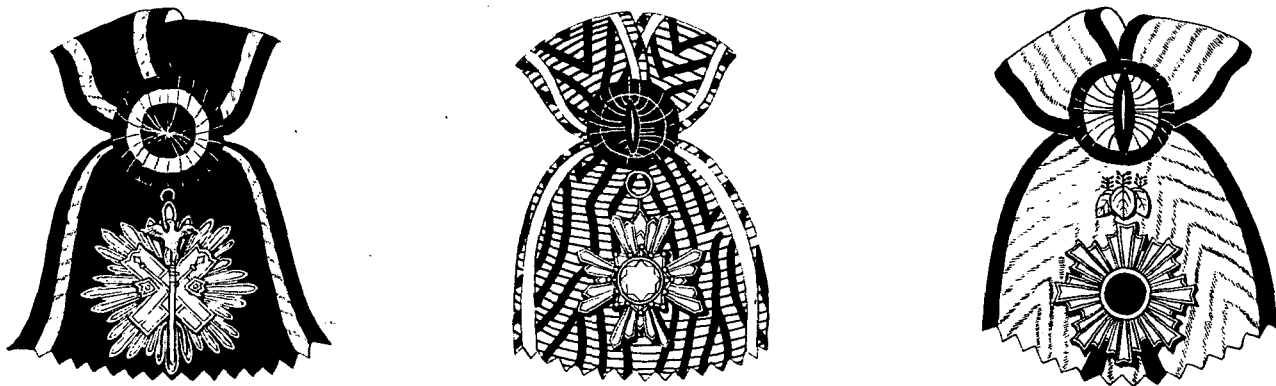

Figure 5. The principal Japanese decorations (only the first class of each order is shown) left to right: Golden Kite, Sacred Treasure, Rising Sun.

tary equipment, and abandonment of sentry posts. Surrender or desertion frequently is the result of harsh discipline, especially corporal punishment or reprimands that humiliate the soldier, and the enlisted man is especially prone to desert or surrender in the event he has reason to believe he has been forsaken by his officers.

Such a man is the Japanese soldier, in so far as

composite portrayals are valid. He knows or cares little about the fundamental issues of the war, nor is he informed about its progress in the far-flung theaters of operations. Propaganda carefully nurtures his hatred of the Allies; his religion, inseparably entwined with his patriotism, convinces him that he is achieving his highest destiny in the noble profession of arms.

CONDUCT IN BATTLE

In combat the Japanese soldier is strong and hardy. On the offensive he is determined and willing to sustain sacrificial losses without flinching. When committed to an assault plan, Japanese troops adhere to it unremittingly even when severe casualties would dictate the need for abandonment or modification of the plan. The boldness and courage of the individual Japanese soldier are at their zenith when he is with his fellows, and when his group enjoys advantages of terrain or fire power. He is an expert at camouflage and delights in deceptions and ruses. Japanese troops obey orders well, and their training and discipline are well exemplified in night operations. On the defense they are brave and determined; their discipline is good and fire control excellent. In prepared positions the resistance of Japanese soldiers often has been fanatical in its tenacity.

Figure 6. A Japanese officer wearing decorations. These are, left to right, Imperial Order of the Golden Kite (4th or 5th grade), Imperial Order of the Double Ray of the Rising Sun with Paulinia Leaves, Manchurian medal, three campaign or commemoration medals, and, around the neck, Imperial Order of the Sacred Treasure (2d or 3d grade).



Surrender is considered a great disgrace not only to the soldier but to his family, and his religion teaches the Japanese soldier that it is the highest honor to die for his emperor. There have been a number of instances where Japanese troops in hopeless positions have fought to the last, and the wounded begged to be killed to avoid the ignominy of capture. "Fight hard," the Japanese soldier is told. "If you are afraid of dying, you will die in battle; if you are not afraid, you will not die. . . . Under no circumstances become a straggler or a prisoner of war. In case you become helpless, commit suicide nobly." Propaganda emanating from Tokyo emphasizes the contention that Americans are individualistic, whereas the Japanese have the advantage of selflessness.

Regimental standards and colors are highly prized, and their loss is considered the greatest dishonor, to be expiated by the death of those entrusted with their custody.

Yet in recent operations there have been pronounced indications that Japanese soldiers are not too eager to die, especially when the odds are against them. Heavy casualties, on occasion, have had a weakening effect on the morale of survivors; a

Japanese order points out that "too many graves with markers are not good for security or morale. Also, it is unfair to erect grave markers for some persons and not for others. Since a grave will be erected at the home of a deceased man, it is not necessary to erect one for him on a battlefield."

Japanese units by no means always have been steadfast under fire; on occasion they have been routed "squealing like pigs". The group pattern of their lives as civilians, with its restraints of religion, deference to the head of the family, and subservience to the state, leaves an indelible impression on the individual soldier who is unimaginative and slow to improvise when thrown upon his own resources. Loss of officers is a great blow to Japanese units, for the enlisted men and noncommissioned officers frequently fail to assert the self-reliance and initiative which their training system seeks to inculcate. Indeed, Japanese troops on occasion have been thrown into panic by an unexpected move by hostile forces or by miscarriage of their own plans.

The Japanese soldier is a notoriously poor marksman; even snipers who are specially picked and trained men fail to capitalize upon the advantages



Figure 7. Regimental colors.

which their infinite patience and skill in concealment otherwise would afford. In some combat areas it has been reported that Allied troops enjoyed virtual immunity to casualties from this type of fire at ranges greater than 50 yards, and snipers seldom have fired at moving targets.

There have been instances when Japanese troops apparently were badly frightened by heavy Allied artillery fire. Nevertheless, it appears that artillery fire for morale effect has not been very profitable; at least there is no conclusive evidence that Japanese troops generally will break until the volume, intensity, and duration of fire are of a magnitude that would unnerve any troops. Likewise, it cannot safely be assumed that the Japanese generally fear concentrated mortar fire, for there have been cases when they advanced undeterred in the face of this fire. They do have a deep respect for the accuracy of

Allied small-arms fire; and the lavish expenditure of ammunition of all types by Allied armies incites their wonder and awe.

While there have been local reports of their troops fleeing in disorder from Allied bayonet charges, the Japanese generally prefer this type of combat. Their training has emphasized the hand-to-hand encounter, they are imbued with the conviction of their superiority in this type of fighting, and they derive confidence from the greater relative length of their bayonets. Their reactions to air attack seem to be the same as those of other armies, although their dismay at the numerical inferiority of their own air forces seems to be deeply tinged with mortification that the "sons of heaven" should be forced to accept a situation in which their enemies are so palpably superior.

CHAPTER II. THE NECESSITIES OF LIFE

ARMY SUPPLY

Naturally the effectiveness and morale of Japanese soldiers are largely conditioned by the efficiency with which the Intendance (supply) Department of the army performs its functions. Regular receipt of pay, adequate rations, suitable clothing, and personal equipment as good as or better than that of the enemy have been prime requisites for efficient soldiers in any army throughout all military history.

The Intendance Department of the Japanese Army, which roughly corresponds to the Quartermaster Corps of the U. S. Army, is responsible for the procurement, storage, and issue of food, clothing, and other supplies, exclusive of matériel issued by the Ordnance Department. The Intendance Department in 1942 had 2,700 officers of which 20 were generals and 630 officers of field grade. There are four sections in the department, dealing respectively with food, clothing and other personal equipment, pay, and housing.

Every division has its intendance section, and the constituent regiments of the division have their subsections, each operated ordinarily by an officer and about eight enlisted men. In the battalion, intendance is handled by a second lieutenant and about ten enlisted men; in the company, by a warrant officer and several supply clerks.

The Intendance Department maintains main freight depots in Japan; there are field freight depots in the theaters of operations which supply branch field depots that fill the requisitions of the division field warehouses. From the division field warehouse supplies go to the regimental distributing centers. Subordinate units use organic transportation in drawing supplies from these centers. Here is the greatest weakness of the Japanese supply system, for forward delivery of the requisite volume of food, munitions, and equipment has failed time and again because of inadequate transport facilities. Then, too, Japanese commanders frequently have overestimated the capabilities of their forces, and their unwarranted con-

fidence in speedy victories has caused them seriously to underestimate their supply needs.

RATES OF ARMY PAY

(One Yen equals approximately 25¢ U. S.)

Rank	Basic pay per month (Yen)	Additional overseas pay		
		China	Thailand and French Indo-China	Other areas
General.....	550.00	475.00	495.00	545.00
Lt. General.....	483.33	410.00	434.00	480.00
Major General.....	416.66	355.00	375.00	410.00
Colonel (3 grades).....	310-370.00	300.00	315.00	345.00
Lt. Colonel (4 grades)....	220-310.00	235.00	245.00	270.00
Major (4 grades).....	170-220.00	175.00	180.00	200.00
Captain (3 grades).....	122-155.00	125.00	130.00	145.00
1st Lieutenant (2 grades)...	85-94.16	95.00	100.00	115.00
2d Lieutenant.....	70.83	90.00	95.00	105.00
Probational officer.....	25-40.00	40.00	45.00	50.00
Warrant Officer.....	80-110.00	95.00	100.00	110.00
Sgt. Major (4 grades)....	32-75.00	75.00	80.00	85.00
Sergeant (3 grades).....	23-30.00	55.00	60.00	65.00

Corporal.....	20.00	23.00	24.00	27.00
Leading Private.....	13.50	15.00	16.00	18.00
Superior Private.....	10.50	12.00	13.00	14.00
1st Class Private.....	9.00	10.00	11.00	12.00
2d Class Private.....	6.00	7.00	8.00	9.00

Payment of the troops is under the Intendance Department. The following table shows the rates of pay in the Japanese Army. It will be noted that overseas pay varies with location. The extra amounts were granted to compensate for rising living costs in Japan and to assure a livelihood for the soldier's dependents by making it possible for him voluntarily to make adequate allotments for their support. Extra pay also is granted to technicians, musicians, and warrant and noncommissioned officers serving in the military police. If a Japanese officer or enlisted man performs the duties associated with a higher rank, he receives the pay of that rank even though he has not been promoted.

There are no compulsory pay allotments in the Japanese Army. Soldiers are encouraged, however, to send home a portion of their pay or to save some of it.

Military Post Office Savings Banks transmit any funds the soldier may wish to send home. The soldier may also have a portion of his pay credited to his personal savings account, the deposits being duly credited in the savings book which every Japanese soldier receives with his first pay. All Japanese officers and enlisted men serving outside Japan proper are issued pay books which show payments due and provide for a systematic recording of amounts paid. No pay can be drawn unless the book is presented and an appropriate entry made.

ARMY RATIONS

There has been much misunderstanding of the food situation in the Japanese Army. Myths have sprung up concerning the ability of the Japanese soldier to subsist on extremely small quantities of food, and it has been popularly believed that he eats little save rice while in the field.

As a matter of fact, when the Japanese soldier gets nothing to eat he becomes just as hungry and dejected as any other soldier. He likes adequate meals at regular times and appreciates variety. Inadequate rations bring their full quota of complaints and exer-

cise a depressing influence on individual and unit morale in the Japanese Army. One Japanese soldier plaintively records in his diary, "If I eat tonight, I may not be able to eat tomorrow. It is indeed a painful experience to be hungry. At the present time all officers, even though there is such a scarcity of food, eat relatively well. The condition is one in which the majority starves." Another complains about the monotony of the rations: "The never-changing soup for the morning meal. Only two meals today—army biscuits to gnaw at in the morning and *miso* soup with watermelon in the evening. Also had some salt beef."

The Japanese field ration is adequate and reasonably tasty; most of its components, after proper inspection, can be eaten by Allied troops. Rice is the stable part of the ration, comparable with bread or biscuit in other armies. Naturally, the Japanese soldier would no more be satisfied with a ration consisting exclusively of rice than an Allied soldier would with bread alone.

The rice, which is cooked dry to the consistency of a sticky mass to facilitate eating with chopsticks, may be either the polished or unpolished variety.

Ordinarily the polished type is used, since it can be kept in the cooked state longer. To ward off beri beri some barley may be mixed with the rice, but this mixture is not overly popular. Instead, the rice usually is cooked with a few pickled plums which not only afford protection against beri beri but also act as a laxative to counteract the constipating effect of rice. To make the rice more palatable, it ordinarily is seasoned with soy-bean sauce or the equivalent powder known as *miso*. Both the sauce (*shoyu*) and the *miso* are prepared from soy-bean seeds, to which malt and salt are added. The resultant products have a flavor similar to Worcestershire sauce and are much like the soy sauce found in all U. S. Chinese restaurants.

Other favored foods are pickled radishes; dried, tinned, or pickled octopus, which would be roughly comparable with canned salmon or herring in other armies; dried bread (hard-baked wheaten cakes), and vegetables. Preserved foods include dried and compressed fish—salmon or bonito which must be soaked and salted to make it palatable; pickled plums, compressed barley or rice cakes, canned oranges and tangerines, and powdered tea leaves. Dehydrated

vegetables, especially beans, peas, cabbage, horseradish; slices of ginger; salted plum cake; canned beef; canned cooked whale meat; confections, and vitamin tablets often are included in ration issues.

The ration is not standardized and ordinarily varies from $2\frac{1}{2}$ to 4 pounds per day for the standard field ration. The ration is calculated in two forms, the normal (fresh) and the special (preserved), depending upon the availability of fresh foods. Quantities also are graduated according to three categories of issues: the basic or full issue distributed when transport is adequate; the issue when transport is difficult; and the third and least quantity, issued when transport is very difficult.

There are two emergency rations. The "A" ration consists of about 1 pound 13 ounces of rice, 5 ounces of canned fish or meat, and a little *miso* and sugar. The "B" ration consists of "hard tack". This comprises three muslin bags of small oval biscuits; each bag contains a half-pound biscuit for one meal. This ration may only be eaten on orders of an officer.

A compressed ration is also available for emergency use. It is made up of a cellophane packet containing cooked rice, pickled plums, dried fish, salt, and sugar.

ARMY RATION SCALES

RATION ITEM	Normal or Fresh Scale	Special or Preserved Scale
	[Figures are ounces ex- cept where otherwise indicated]	
Rice, or rice and barley.....	28	
Compressed rice.....		20
Fresh meat or fish.....	7.4	
Canned meat or fish.....		5.3
Fresh vegetables.....	21.2	
Canned vegetables.....		4.2
Pickled radish.....	2.1	
Dried plum.....		1.6
<i>Shoyu</i> (sauce).....	1.7	
Powdered <i>miso</i>		1.1

Bean paste.....	2.6	
Salt.....	0.5	0.5
Sugar.....	1	1
Tea.....	0.2	0.2
TOTAL	4 lb.	2 lb. 2 oz.

An iron ration is issued only to parachutists. Weighing half a pound, this ration consists of wafer-like biscuits made of ground rice and flavored with sesame seed, and an extract made from mussel flesh, dried plums, preserved ginger, crushed soy beans, and *mori* (a form of dried seaweed).

An emergency air-crew ration found in New Guinea contained 20 ounces of unpolished rice, puffed wheat, biscuits, dried fish, two small bottles of concentrated wine (35 percent alcohol), candy, large salt tablets, and a water-purifier kit. The entire kit was packed in five transparent water-proof bags.

On Bougainville a "Polished Rice Combination Case" was found which contained 40 portions, mostly



rice, loose-packed in an air-tight tin case enclosed in a wooden crate. This, in addition to the rice, contained *miso* paste, vitamin-B concentrate, vitamin A and D tablets, powdered tea (vitamin C), fuel, and matches. These ingredients were packed in 3-ounce cans, with one can intended apparently for every two portions of rice.

Every opportunity is utilized to augment the normal ration issue. Fishing, gardening, and purchases from natives frequently afford welcome additions to the daily diet as well as variety. Foraging, both organized and unorganized, also is resorted to if the country is sufficiently well stocked to make such enterprise profitable. The Japanese soldier is very fond of confections, and these he may secure in the "Comfort Bags" sent by relatives and friends at home.

The transport of rations naturally varies with the terrain, the nature of the military operations, the availability of local food sources, and other factors. In New Guinea emergency rations sufficient for 12 days were carried by a battalion of 700. Each man

Figure 8. Chow line and cook stove.

Clothing and Personal Equipment Issued in the Japanese Army

Helmet, steel.....	1
Cap, cloth, khaki, peaked.....	1
Trousers, drill, long, pairs.....	2
Tunics, drill.....	2
Shirts, cotton khaki.....	2
Underwear, cotton sets.....	2
Socks, cotton pairs.....	2
Shoes, split-toe, rubber, pairs (<i>Tabi</i>).....	1
Boots, leather, pairs.....	1
Shelter half, khaki, waterproof.....	1
Puttees, pairs.....	1
Pack.....	1
Haversack.....	1
Hold-all, canvas.....	1
Mess tin.....	1
Belt, leather.....	1
Pouches, leather, ammunition.....	3
Water bottle.....	1
Gloves, mosquito, pairs.....	1
Head mask, mosquito.....	1
Respirator.....	1
First aid field dressing.....	1

carried a three-day supply of "fresh" food and a four-day supply of "preserved", with the remainder, aggregating 2.98 tons, carried in the battalion train. In another instance an infantry regiment carried rations for ten days, with four days calculated on an emergency basis. But the Japanese have made marches with only a five-day supply. Packaging was quite inferior in the early days of the war, and much canned and dehydrated food was lost as a result of this deficiency. Considerable improvement has been noted, however, in recent operations.

ARMY UNIFORMS

The Japanese Army long had been in need of a modern uniform when the present one was adopted in 1938. Its design dates back to 1930 when the demand for a comfortable field uniform capable of mass-production in war was found to be urgent. Although the "China Incident" provided a tardy excuse for the inauguration of a new program, it has proven impossible to replace all old uniforms. Those possessing them retain them as a "B" (fatigue and combat) uniform, and will wear them until worn out. These old, mustard-color uniforms are identified by an



uncomfortable standup coat collar similar to that used by the U. S. Army in the last war. The design of these old uniforms dates back to 1911 when the similar blue uniform of the Russo-Japanese War was replaced.

The new uniforms have a turn-down coat collar which may be worn open in the summer or in the tropics. The coat for noncommissioned officers and men is single-breasted with five buttons and four flapped pockets, the two breast pockets having buttoned flaps. Trousers are styled like breeches and secured with tapes at waist and ankle. All except mounted troops (who wear leather boots or leather puttees) wear wool wrap puttees and high pigskin or cowhide shoes. The marching shoe usually has unfinished leather on the outside, and may have either a leather hobnailed sole or a rubber sole with rubber cleats. *Tabi* (split-toe sneakers) are issued in all climates. Undershirts are usually gray or white, with single breast pockets. Caps are of wool with a chin strap and, on the front, a gold Army star. For winter, coat and trousers are of olive-drab wool. In summer these

Figure 9. *Enlisted men in M98 uniform (opposite page).*



Figure 10. "Tabi."



garments are exchanged for khaki cotton twill coat and breeches of identical cut. Late issues of cotton twill uniforms appear more greenish than tan.

The overcoat is single-breasted, with two side slash pockets and a buttoned-on hood with typical throat-piece closure. Guards Cavalry detachments wear officers' overcoats. Some double-breasted overcoats may be worn by other troops but (except for Guards Cavalry) overcoats and coats for all noncommissioned officers and men are characterized by a loop which buttons up over the belt on the left side in order to sustain the weight of the bayonet and scabbard. The overcoat also has button holes permitting the lower front corners of the coat to be buttoned up behind the side pockets. This frees the legs for marching and prevents wear.

The raincoat is similar in all respects to the overcoat and is of greenish khaki color.

Officers wear coats not unlike those issued to enlisted men. However, officers' uniforms are not issue clothing. Wide variance in quality, color, and cut

Figure 11. Noncommissioned officers in M90 full field dress (opposite page).

exists. In general, officers' uniform coats are merely conversions of the old coat made by sewing on a turn-down collar over the old stand-up collar. Officers' overcoats are double-breasted and have fancy belts in back and a slot for a sword on the left side. Company officers wear one, field officers two, and general officers three broad cloth bands on their cuffs. Warrant officers wear a band of intermediate size, while noncommissioned officers wear one narrow cloth band on their type of overcoat.

Instead of raincoats, officers wear raincoats with hood and throat closure. Officers also wear black footgear—high shoes with wrap or black leather puttees or riding boots. Officers and warrant officers almost always carry swords; noncommissioned officers are sometimes entitled to carry them.

Many special types of clothing are issued for various climates and areas. Development and issue of winter clothing on a large scale began as long ago as 1932, with the occupation of Manchuria. Winter clothing includes heavy pile-lined caps and overcoats. The latter have a peculiar feature in that the sleeves are quickly removable either at shoulder or elbow in order that proper sleeve sizes may be fitted without



Figure 12. Enlisted man in M90 full field uniform, with old cap and insignia.



Figure 13. Enlisted man in M90 uniform, fitted with M98 cap and insignia.



Figure 14. Enlisted man in M98 full field uniform, with all insignia removed.



Figure 15. Enlisted man in M98 overcoat. Insignia is worn on the collar.

altering the overcoat. Other common items of winter issue are fur leggings, trigger-finger mittens, wool underwear, heavy padded trousers and jackets for fatigue work, and felt boots.

Tropical clothing remains a subject for continuing experimentation by the Japanese Intendance Department. The ordinary summer cotton uniforms have proved very suitable, since the material is heavy enough to be mosquito-proof and to withstand adequate wear. The summer coat has been modified, however, and fitted with flaps under the arm pits which may be buttoned open or closed. Recent coats also have open seams under the armpits for added ventilation on the march. Under the coat is worn a cotton twill shirt with reinforced collar, which may be worn without the coat. Modified trousers are issued with the lower part of the legs abbreviated and a drawstring fitted so that they may be secure around the puttees in mosquito country, and left open for coolness whenever possible. Various types of light shirts and trousers of various weights and lengths have been issued but the above-mentioned garments appear standard. At Hollandia and in Burma there have been found complete sets of

tropical lightweight uniforms, all components being of the same flat-green hue. These include *tabi*, light wrap puttees, breeches, muslin shirt, coat, and cap. The uniform is very comfortable, but it is too light to provide protection against mosquitoes and to sustain even normal jungle wear.

ARMY INSIGNIA

Although security-conscious Japanese commanders had, previous to the war, sought to hinder Allied Order-of-Battle Intelligence by prohibiting the wearing of arm and unit insignia in combat areas, convenience has induced many units and even field armies to adopt identification systems. The widespread demand for unit, arm, and personal identification apparently has received official recognition, and as of 1 January 1944 a new set of uniform regulations were reported to have taken effect.

Under the present system, not yet displaced by the new order, rank insignia are properly worn on the collar. Insignia of arm are indicated by inverted "W's" worn over the right breast pocket. Further differentiation within arms, or indication of status as student, cadet, probationary officer, and like cate-



gories, is indicated by a symbol worn on the collar behind the rank insignia. Unit numbers may be worn either behind the rank insignia, or behind the arm, the cadet, or other symbols if such are worn.

In practice only the medical troops appear to wear their branch color (green). Rank insignia may be worn on the breast or arm. Frequently a standard form of patch is made up by a division, which includes a regimental symbol, the badge of rank of the wearer, and his name. Sometimes the name or part of the name of the unit commander is furnished. There is no practice common to all units; the widest variety prevails.

Figure 16. M90 officer's field uniform (opposite page, left).

Figure 17. Officer in M98 uniform (opposite page, right).

OTHER SUPPLIES

Besides food and clothing, the Intendance Department issues to the Japanese soldier certain "daily articles". "Daily Article A," issued monthly, includes 150 sheets of toilet paper, ten plain and ten picture postcards, writing paper, envelopes, and a pencil. "Daily Article B," issued every two months, includes a small hand towel, a loin cloth, soap, tooth powder, and a tooth brush. Certain recreational items such as phonographs and records, chess boards etc., are also issued.

Canteens in the Japanese Army (comparable with U. S. Army post exchanges) obtain their stocks from the Intendance Department, which also controls prices. There is no evidence that private contractors have been permitted to operate army canteens. The list of items on sale in the canteen of a special landing force shows a considerable variety of goods at prices reasonably in line with the pay of Japanese soldiers.



Fig.18. Japanese officers in Berlin (three figures at the right). Fig.19. Officers in winter overcoats (opposite page).



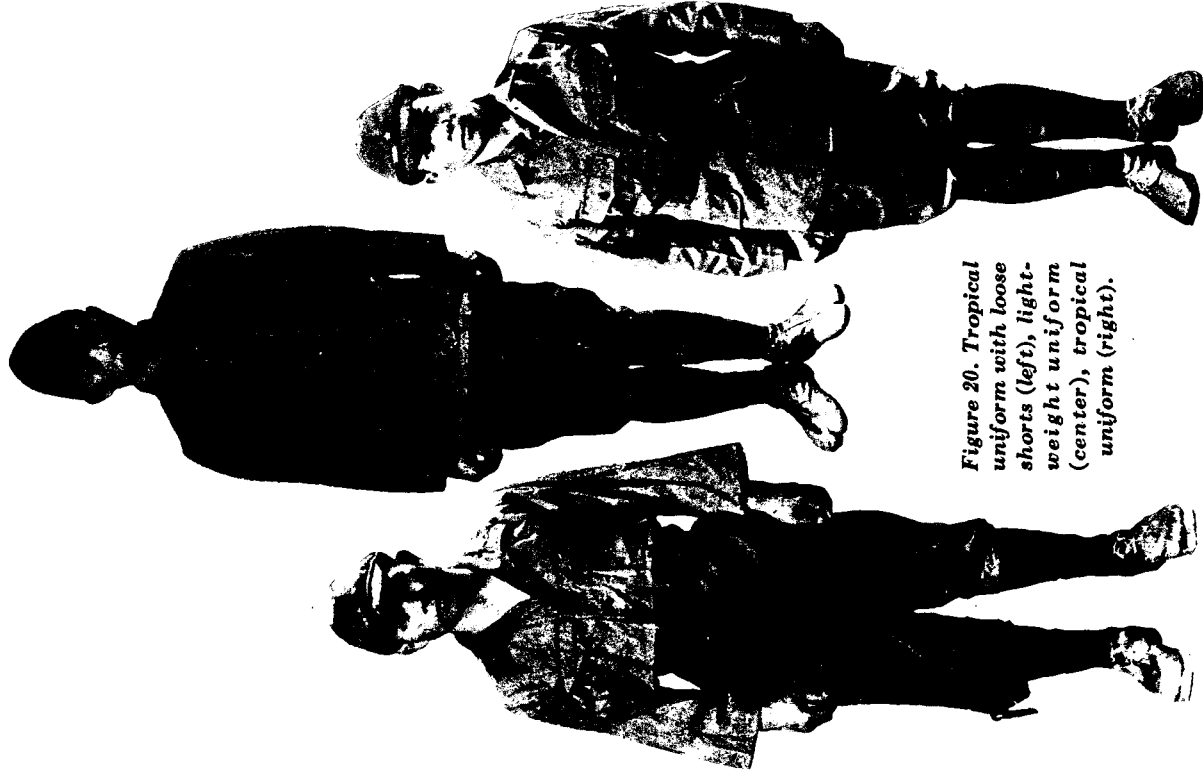

Figure 20. Tropical uniform with loose shorts (left), lightweight uniform (center), tropical uniform (right).

ARTICLES SOLD IN JAPANESE ARMY CANTEENS

ARTICLE	PRICE* Yen Sen	ARTICLE	PRICE* Yen Sen	ARTICLE	PRICE* Yen Sen	ARTICLE	PRICE* Yen Sen
Sake, † Tohiman Brand.....	1.70	Salmon, canned.....	.60	Clothes-pins.....	.03	Tissue, facial.....	1.00
Sake, Ozeki Brand.....	2.00	Mineral water, Jintan Brand,		Safety-pins.....	.07	Writing paper.....	.07
Beer, Asahi Brand.....	.40	medium size.....	.26	Thread, white.....	.13	Postcards, military (100	
Cider, Kirin Brand.....	.22	Yeast tablets, Wakamoto		Paste.....	.11	cards).....	.25
Cigarettes, Homare Brand.....	.05	Brand.....	1.20	Clasps.....	.05	Envelopes.....	.05
Cigarettes, Hikari Brand.....	.08	Meat extract, Plum Brand.....	1.00	Knife.....	.13	Note-books, small.....	.06
Cigarettes, Kinshi Brand.....	.05	Socks, white cotton.....	.22	Scissors.....	.22	Note-books, loose-leaf.....	.04
Milk, canned.....	.55	Socks, grey.....	.28	Soles, rubber.....	.34	Ink, Raito Brand.....	.27
Handkerchiefs.....	.17	Shirts, striped.....	1.20	Heels, rubber.....	.23	Red ink, Kikusui Brand.....	.12
Candy drops.....	.10	Under-abouts, striped.....	1.20	Prophylactics.....	.03	Ink, Japanese.....	.14
Caramels.....	.10	Trunks, knitted.....	4.20	Note-books.....	.12	Penholder.....	.05
Fruit jelly.....	.10	Trunks, cotton.....	.97	Tooth powder, Lion Brand.....	.11	Pen points.....	.03
Sweet bean paste, Yokan		Towels.....	.22	Tooth paste, Lion Brand.....	.18	Pencil.....	.05
Brand.....	.11	Face towel.....	.22	Shoe polish, Taido Brand.....	.60	Voucher slips.....	.05
5 colored candy drops.....	.11	Cloth, loin.....	.15	Pineapple, canned.....	.50	Toothpicks.....	.11
Sugar candy, Homare Brand.....	.10	Scarf, white.....	.33	Soap, Kwao Brand.....	.11	Toothpick box.....	.08
Biscuits.....	.10	Splrs, inner.....	.05	Soap, laundry.....	.30	Clothes brush.....	.28
Pears, canned.....	.55	Garters.....	.72	Fountain pen, Victor Brand I.	2.00	Shoe brush.....	.20
Peaches, white, canned.....	.55	Buttons, raincoat (per pkt.)..	.03	Fountain pen, Victor Brand		Soap box.....	.23
Crab, canned.....	.70	Buttons, suit, black or white..	.07	II.....	2.80	Writing pad.....	.15

* One hundred sen equal one yen; one yen equals approximately 25¢ U. S.

† A liquor distilled from rice; about one third the strength of gin.



PERSONAL EQUIPMENT

A large part of Japanese personal equipment is modern in design, and is the result of a replacement program still under way. Although a great effort was made for years to condition Japanese civilians for the sacrifices of preparedness and war, the peacetime strain on the Japanese economy prior to the "China Incident" caused military authorities to hesitate to impose additional burdens, especially for clothing and personal equipment.

The design of most such items then in use dated back to World War I and before, and experience in the field and in manufacture had long indicated the necessity for improvements. In close emulation of the German Army the Japanese were using leather for belts, packs, and ammunition pouches, as well as for carriers and personal combat gear in general. Leather was difficult to procure, however, and it was unsuitable either for arid conditions on the continent of Asia or for tropical moisture. As soon as the outbreak of the China War in 1937 furnished an excuse, a

Figure 21. Packs from the rear.

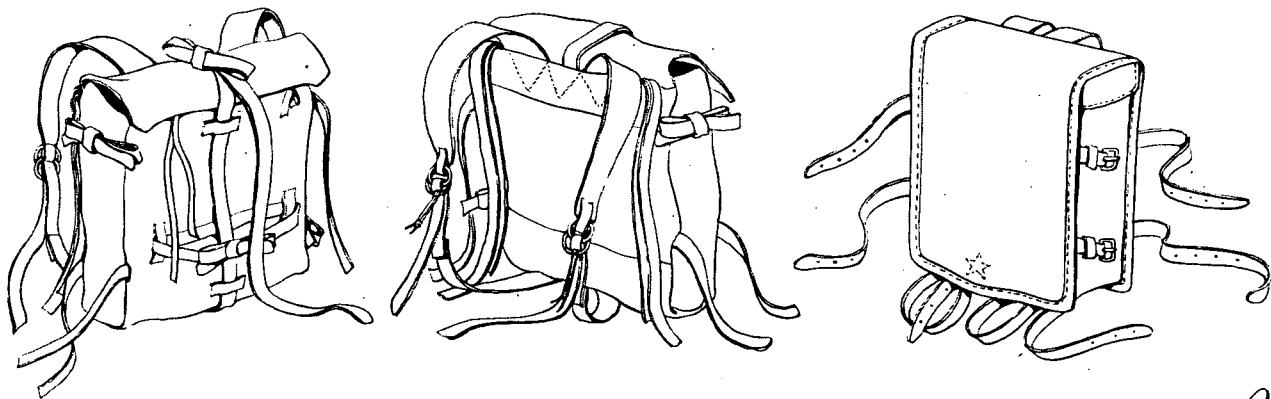
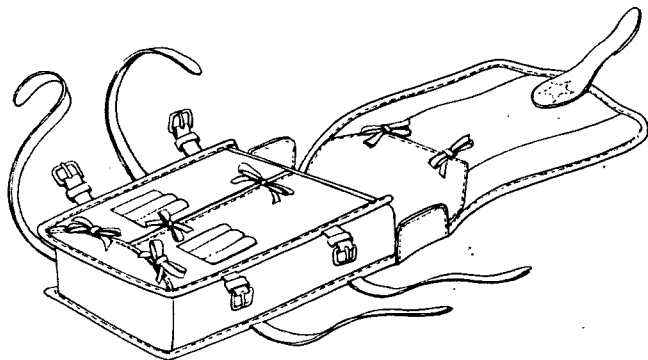
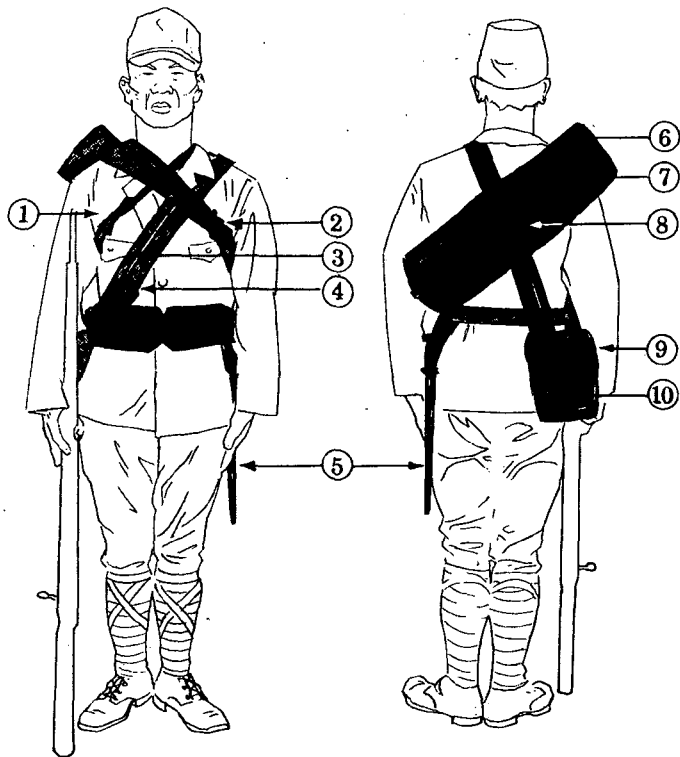

Figure 22. Front and rear views of packs for non-commissioned officers and enlisted men (above); for officers (right).

large-scale replacement program was instituted. A linoleum-like material of rubberized fabric, or canvas, or cotton duck was substituted for leather. In general, belts, ammunition pouches, instrument cases, holsters, and the like are of rubberized fabric while bandoliers and packs are of canvas or cotton duck. Certain items, like carriers for grenade-dis-





charger projectiles, have water-proofed tops and may be part duck and part rubberized fabric. Only officers' equipment tends to remain in leather. In 1943 further improvements were made, and belts were issued which have the appearance of fuzzy leather but which are actually a further development of rubberized fabric.

Of the several types of packs in use in the Japanese Army the most common is the cotton duck pack issued to noncommissioned officers and men. This pack is 13 inches square and 5 inches deep, and is readily identified by some 20 tapes which are used to secure the top flap and to bind gear on the pack's exterior. This pack is a modification of its predecessor, a leather German-type pack with fur-covered back flap.

The pack normally contains extra shoes, socks, and breech clout. Towel, soap, and other miscellaneous toilet articles are carried, as well as a first-aid packet and a sewing kit. A shelter half, although

Figure 23. Canvas hold-all as a combat pack: (1) pack strap cross knot, (2) main pack strap knot, (3) canteen strap, (4) haversack strap, (5) bayonet, (6) tent section, (7) overcoat, (8) tent and overcoat are folded in four equal parts, (9) haversack, (10) canteen.

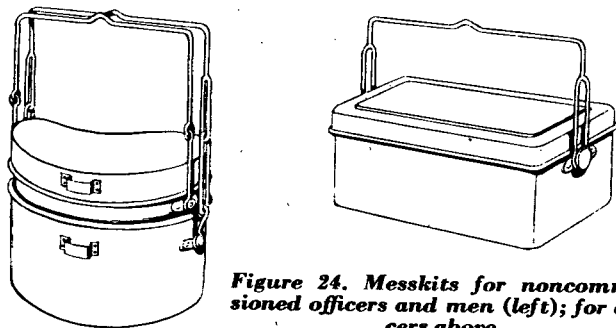

Figure 24. Messkits for noncommissioned officers and men (left); for officers above.

only 4 feet 10½ inches by 2 feet 5¼ inches, is very serviceable. It is used as a ground sheet, or to roll up in. When the tent ropes are properly roved through the eyelets, the shelter half makes an excellent poncho and, because of its superior rain-shedding quality, Japanese soldiers prefer it to the issue raincoat. A blanket or overcoat may be rolled in inverted U-shape and tied around the edges of the pack. A raincoat, shelter half, and camouflage netting are placed across the top, and the mess kit is strapped to the back of the pack. When caps are worn, the steel helmet is secured over the mess kit.

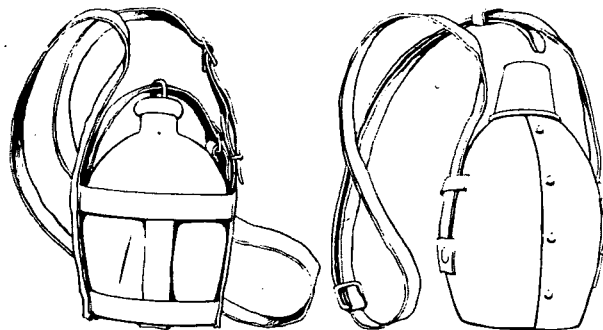

Figure 25. Canteens for noncommissioned officers and enlisted men (left); for officers (above).

Instead of the pack a canvas hold-all is sometimes used. This is simply a piece of light canvas with carrying straps at each end, and two long tapes, with shorter tapes to help secure the load. When rolled it can be carried across the back, slanting diagonally upwards from left to right, the straps and long tapes making an X across the chest where they are knotted. The hold-all serves as a combat pack and usually includes overcoat or blanket, shelter half, and tent poles and pins, besides whatever gear is not

carried in the haversack. Canteen, ammunition pouches, and gas mask and carrier complete the combat gear normally carried by the Japanese soldier.

At one time a special noncommissioned officer's pack was issued. It may still be found and may be identified by its oblong shape and its size, which is smaller than that of the standard pack described above. Officers carry a leather pack 9 inches wide, 11 inches high, and 3 inches deep. This is usually carried over the right hip just behind the canteen.

The mess kit for noncommissioned and enlisted men is of the same type used by the German, Italian, and Soviet armies. It consists of an aluminum container 7 inches wide and 6 inches high, slightly curved in shape in the manner of the U. S. Army canteen. Beneath the cover are one or two nested trays, which, including the cover, provide up to three dishes besides the main deep mess can. If climate permits, ready-cooked food for several days is carried. Officers may use an oblong mess kit slightly smaller in size.

Canteens are of two types. That for officers is much like the German. It has a felt snap-on cover and is topped by a cup. It hangs over the right hip,

slung from a leather strap across the left shoulder. The type for personnel of lower grades is of brown-painted aluminum, of 3- and 4-quart sizes, and is carried in a manner similar to the officer's but with a canvas carrier and strap.

Certain noncommissioned officers and usually all commissioned officers carry leather map cases and rubberized fabric pistol holsters. The latter are usually carried on the left hip, the former just in front of the holster. Haversacks of light cotton duck are similar in appearance to the German and are worn under the canteen by all enlisted men and noncommissioned officers. All the items are carried slung from a strap running over one shoulder.

Ammunition is carried in pouches strung on the waist belt. In front are two pouches, each holding six 5-round clips. The rear pouch is larger, holds 12 clips, and has a fitting for an oil can on the right side. The bayonet frog is also fitted to the belt and is worn on the left side.

The gas mask is contained in a carrier similar to the British. Normally it is slung on a broad canvas

Figure 26. Troops in action showing field equipment (opposite page).



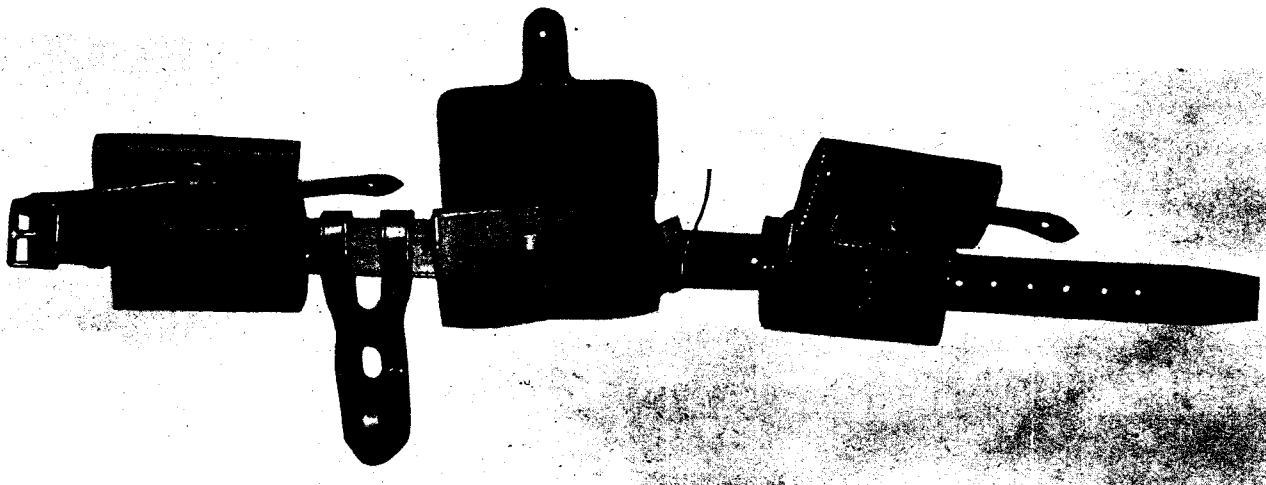

Figure 27. Belt and ammunition pouches.

strap across the right shoulder and rests on the left hip. In the ready position it is worn high on the chest.

Each Japanese infantryman is supplied with an entrenching tool. There are two shovels to every pick. The shovel handle can be removed from the blade

and both secured to the pack, or both can be carried as a complete unit by a cord sling.

Special equipment is issued for jungle operations. Tree climbers which can be tied under the instep are used by snipers. Mosquito headnets and bars, mosquito-proof gloves, and insect-repellent likewise are

issued to troops in the jungle. A water purification kit, including a phial of chemical purifier and a measuring spoon in a flat tin, also is carried. Water purifiers of chemically treated cotton wads in a plastic receptacle also are used, but are not considered satisfactory by Allied armies.

For cold climates woolen blankets are issued. These do not properly merit the designation "wool", since their quality is so low that only 8 percent wool may be found in recent issues; the remainder of the material is cotton and rayon in approximately equal quantities. Such blankets offer little protection, and on Attu as many as seven were issued to each man. Mess kit and canteen covers of duck, lined with kapok or similar insulating material, are also provided for freezing weather; skis, snowshoes, and ice-creepers are available when needed.

Figure 28. Gas mask in alert position.





Figure 29. Jungle troops detrucking.

CHAPTER III. INFANTRY WEAPONS

Despite the comparatively recent industrialization of Japan and her close—even slavish—imitation of foreign matériel, Japanese infantry is well-armed and equipped. The Japanese are capable of producing first-class weapons of their own design, but their production will not reach the volume achieved by other highly industrialized nations.

The Japanese have shown an ability to profit from their combat experience in the present war by modifying the design of their weapons and equipment to meet new conditions. For example, at the beginning of the war Japanese infantry units for the most part were equipped with the Model 38 (1905) 6.5-mm rifle and Models 11 (1922) and 96 (1936) 6.5-mm light machine guns. While these weapons were useful in jungle fighting, because of their lightness and portability, the muzzle velocity and weight of the bullets were inadequate. Consequently, the Japanese Army began to replace these weapons with 7.7-mm models. On the Aleutian island of Attu whole units were found equipped with the new rifle,

as well as with the heavier-caliber light machine gun.

The 75-mm Model 38 mountain gun is being replaced by the superior Model 95; on Saipan Island (Marianas Group), 18 guns of this model were found out of a total of 39 guns and howitzers of 75-mm caliber.

Since the death in 1925 of the Emperor Taisho, Japanese ordnance has been marked with the last two digits of the year since the foundation of the Japanese Empire. The Japanese assert their empire was founded 2,604 years ago—which in our chronology would be 660 B.C. The Japanese calendar year will therefore be our year plus 660. For example, our year 1930 would be the Japanese year 2590. A piece of ordnance adopted in 2590 (1930) will be labeled by the Japanese as Model 90. Beginning with 2600, however, only the last digit has been used, so that a model produced in that year (our year 1940) will be Model 0; one produced in 2601 will be Model 1, etc. Some ordnance also may be found marked with the year of the reign of Hirohito, the present emperor,

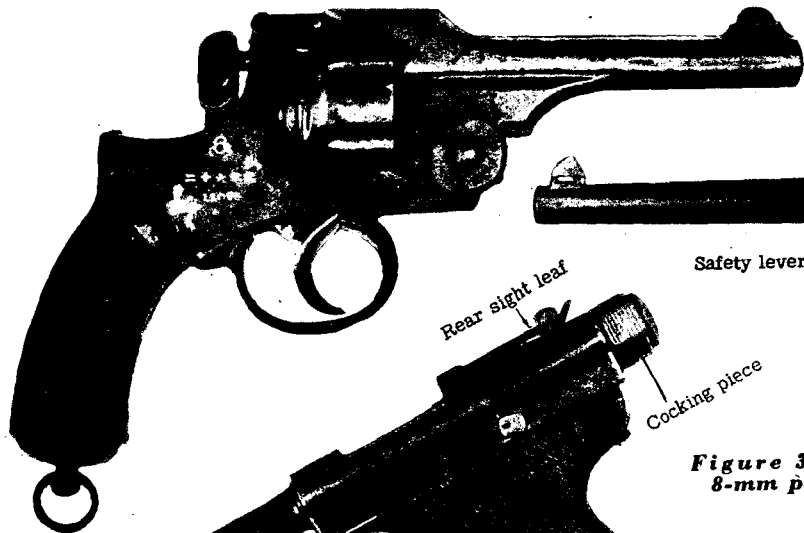

Figure 30. Model 26 (1893) 9-mm revolver (left).

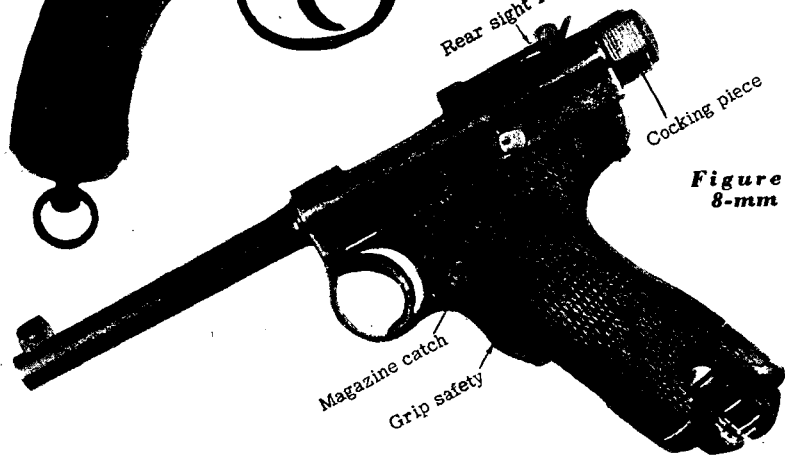

Figure 31. Nambu 8-mm pistol (left).

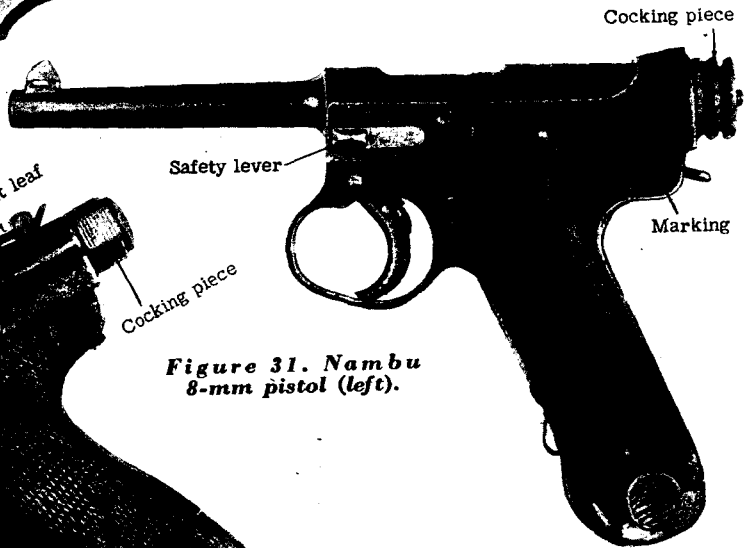

Figure 32. Model 14 (1925) 8-mm pistol (above).

which began in 1925 (Japanese year 2585).

Calibers are given in metric units, but in the case of a number of Japanese weapons these will be approximations. For example, the Model 88 (1928) 7-cm high-angle gun is really a 75-mm antiaircraft gun. Calibers up to 70-mm usually are expressed in millimeters; larger ones may be given either in millimeters or centimeters.

SMALL ARMS

Pistols

The Nambu 8-mm pistol resembles the German Luger outwardly but its mechanism is entirely different. Although both this pistol and the Model 26 (1893) 9-mm revolver are still in service, they are being replaced by the Model 14 (1925). The Nambu pistol is a semiautomatic, recoil-operated, magazine-fed hand weapon. Its eight-round magazine fits into the butt and is held secure by a catch similar to that on the U. S. service automatic pistol (M1911 or M1911A1 Colt .45). A wooden holster which has a telescoping section is used both as a holster and as a stock which may be attached to adapt the pistol for use as a carbine.

A grip safety just in front of the trigger guard catches the trigger in its forward position and prevents any rearward movement unless the safety is depressed.

To load and fire, a magazine is inserted into the butt and

shoved home until the magazine-catch locks. To move a cartridge for firing, the cocking piece is pulled to the rear and let snap forward again. The pistol then can be fired by squeezing the grip safety and the trigger at the same time.

To unload, the magazine catch is pressed, allowing the magazine to drop out of the butt. The cartridge in the chamber is extracted by pulling the cocking piece to the rear as far as it will go, and letting it snap forward. As a safety precaution this operation should be repeated several times.

The Model 14 (1925) 8-mm pistol is an improvement on the Nambu and uses the same kind of ammunition. Its design is original but the workmanship is rather poor. Unlike the Nambu, the weapon is not fitted for a shoulder stock. Other identification features that distinguish this weapon from the Nambu are the absence of a leaf sight, horizontally grooved wooden grips on the stock, and the absence of a recoil-spring housing on the left side of the receiver.

The weapon is a semiautomatic, recoil-operated, and magazine-fed. It has no slide; the barrel is extended to the rear and carries the ejection opening and sear for the bolt lock. The bolt moves inside this barrel extension, and energy for the forward movement is supplied by two coil springs situated one on either side of the bolt inside the barrel extension.

A safety lever is located on the left side of the receiver just above the trigger. When this is in the forward position the pistol can be fired; when in the rear position, the action is locked.

To load and fire, a loaded magazine is inserted into the well

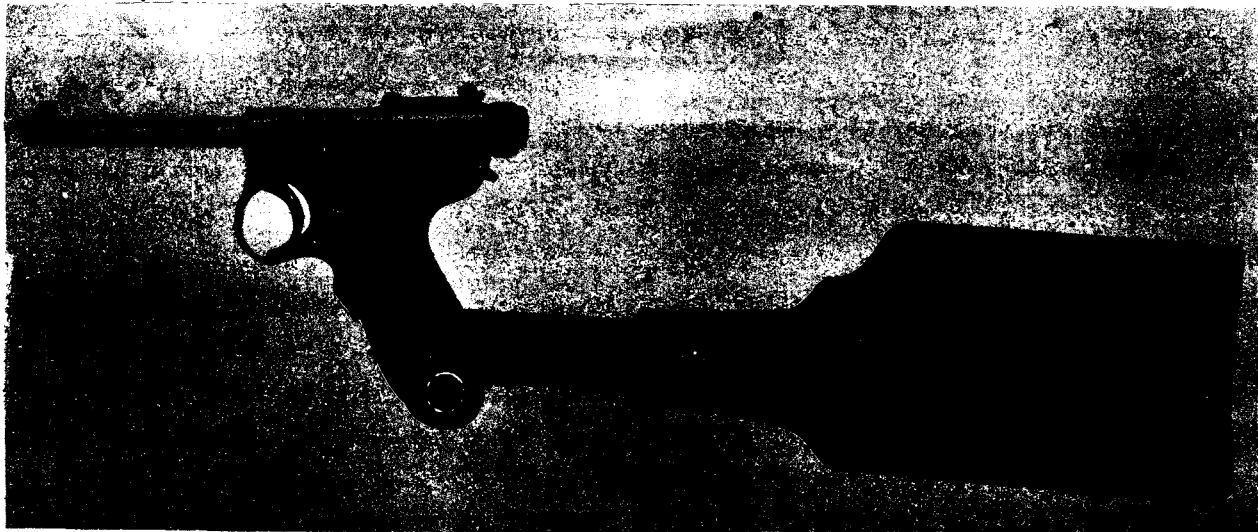
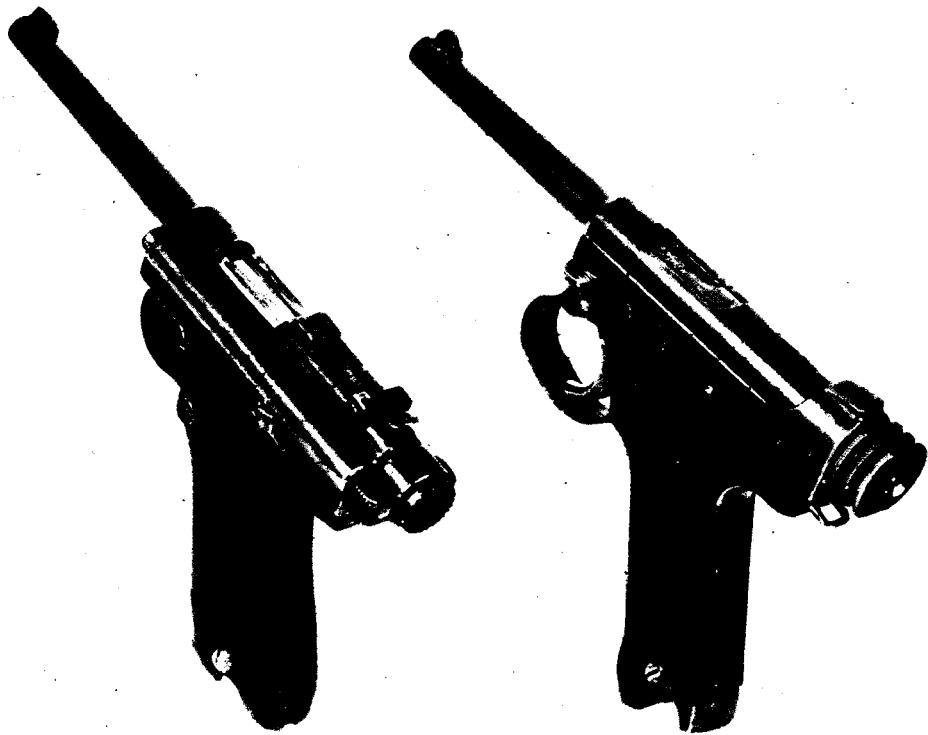

Figure 33. Nambu 8-mm pistol and shoulderstock.

in the butt, while the safety lever is in the forward position. The cocking piece then is pulled rearward as far as it will go, and permitted to snap forward. The pistol then is loaded and ready to fire. It can be unloaded by pressing downward on the magazine, with the safety lever in the forward position. The button on the right side of the stock must be released, after

which the magazine can be extracted. The cocking piece is pulled all the way back to eject a cartridge from the chamber.

Latest pistol model in use by the Japanese Army is the Model 94 (1934) semiautomatic 8-mm pistol. The quality of manufacture is poor in comparison with the Nambu and the Model 14.



*Figure 34. Nambu and
Model 14 8-mm pistols.*

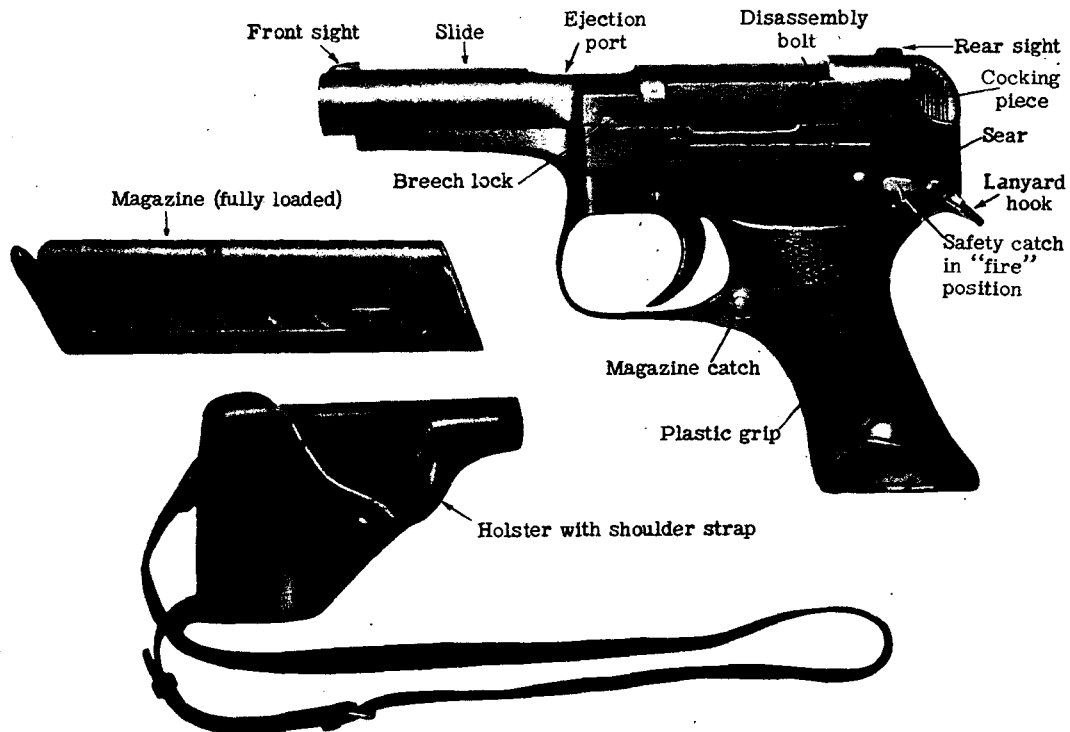

Figure 35. Model 94 (1934) 8-mm pistol, magazine and holster.

This weapon is easily identified by its cramped grip, short barrel, and the slide which covers the entire barrel. It is semiautomatic, recoil-operated, and magazine-fed. The magazine is box-shaped and fits into the butt in the usual fashion.

A safety lever is on the left side of the receiver. When it is in the horizontal position, the pistol can be fired; when it is pulled backward and up to the vertical position, the safety is operative.

The pistol is loaded by inserting a magazine into the butt until the catch clicks. With the safety in the horizontal (fire) position, the cocking piece is pulled to the rear as far as possible and then permitted to snap forward. To unload the magazine, the catch on the left side of the receiver is pressed inward and the magazine is extracted. The piece is "cleared" by working the slide back and forth several times, as would be done with the U. S. automatic pistol.

Pistols—Table of Characteristics

Nambu 8-mm

Caliber.....	0.315 inch
Principle of operation.....	Recoil-operated, semiautomatic
Ammunition.....	Semirimmed, bottle-necked case, roundnose bullet
Capacity of magazine.....	8 rounds
Effective range.....	50 feet
Muzzle velocity.....	950 feet per second

Model 14 (1925) 8-mm

Caliber.....	0.315 inch
Principle of operation.....	Recoil-operated, semiautomatic

Ammunition.....	Semirimmed, bottle-necked case, roundnose bullet
Capacity of magazine.....	8 rounds
Effective range.....	50 feet
Muzzle velocity.....	950 feet per second

Model 94 (1934) 8-mm

Caliber.....	0.315 inch
Principle of operation.....	Recoil-operated, semiautomatic
Ammunition.....	Same 8-mm semirimmed, bottle-necked cartridge as used in the Nambu and the Model 14 pistols
Capacity of magazine.....	6 rounds
Effective range.....	50 feet
Muzzle velocity.....	900 feet per second

Rifles

The Model 38 (1905) 6.5-mm rifle, widely used by the Japanese, is a modified German Mauser with an action somewhat similar to that of the U. S. caliber .30 (7.62-mm) M1903 Springfield. It is a small-bore weapon, with medium muzzle velocity. Although the design is rather clumsy, the mechanism is sturdy despite the lightness of the weapon in proportion to its length. Because of the long barrel, small caliber, and comparatively low muzzle velocity, there is practically no flash, and the recoil is slight in view of the small caliber and the lightness of the bullet. The low muzzle velocity and lightweight bullet have proved unsuitable in combat, however, with the result that the Model 99, with a caliber of 7.7-mm, is now superseding it.

Transport and Engineer troops in the Japanese Army usually are equipped with a carbine version of the Model 38. This has a shorter barrel than the rifle, and a smaller rear sight.

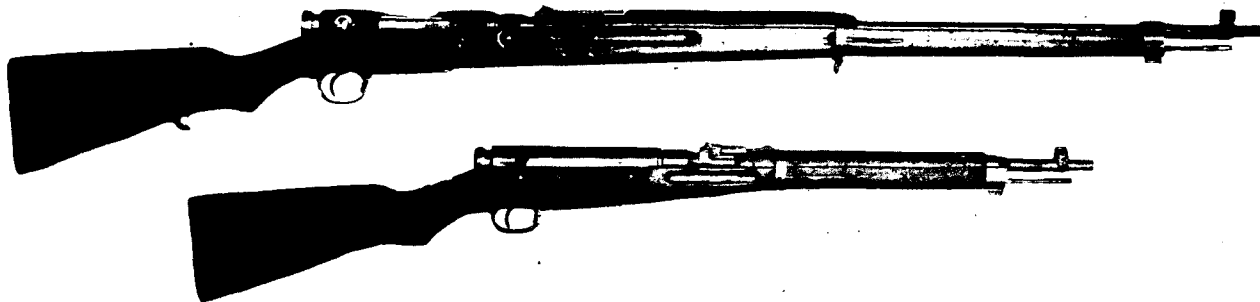

Figure 36. Japanese rifles: Model 38 (1905) 6.5-mm rifle (above) and Model 38 (1905) 6.5-mm carbine.

Another distinguishing feature is the attachment of the sling to the side. Besides this carbine, there is a later model carbine, the Model 44 (1911) 6.5-mm cavalry carbine. It differs from the Model 38 carbine by having a bayonet which folds under the barrel when not in use.

The Model 38 rifle is most easily identified by its unusually long length. It has sling swivels underneath the barrel and stock, as do U. S. Garand and Springfield rifles. It is manually operated and has bolt action. It is loaded with a clip containing five cartridges in a manner similar to the loading of the U. S. Springfield. The sheet-metal dust cover of the bolt, which slides with it in loading and extracting, can be detached. Japanese soldiers seldom use the weapon without removing this cover.

The safety, a cylindrical cap on the rear end of the bolt, can be locked only when the action is cocked. The safety cap then is pushed forward with the palm of the hand and turned clockwise as far as it will go.

To load, the bolt is pulled fully to the rear. One end of the loaded clip is then placed into its guide seat in the receiver and pressed downward until the top cartridge is caught by the lips of the magazine. When the bolt is closed, the empty clip is expelled. A cartridge is chambered when the bolt is pushed forward, and the piece then is ready to fire. Working the bolt back and forth will remove all cartridges from the magazine and chamber.

Ammunition fired in the Model 38 is the standard 6.5-mm. It is semirimmed and has a pointed nose. The rifle also fires

the reduced-charge ball ammunition made for Models 11 and 96 of the 6.5-mm light machine guns. Ball ammunition is distinguished by a pink band around the bullet at its junction with the cartridge case. Tracer ammunition has a green band.

The Model 99 (1939) 7.7-mm rifle—in some combat areas at least—is replacing the Model 38 as the basic Japanese military rifle. It is generally identical in construction with the Model 38 but is 5 inches shorter.

Other identifying features are the monopod attached to the

lower band, which can be rotated forward to catch on the stock when not in use; the sling attachment to swivels on the left side of the rifle; and the slide on the rear sight which has two arms that can be swung out, one left and one right, from the center of the rifle. A long version of this weapon also has been issued.

The Model 99 is manually operated and has a bolt action. It is equipped with a full-length cleaning rod that fits into the stock and is held in place by a catch. A peculiar feature of the

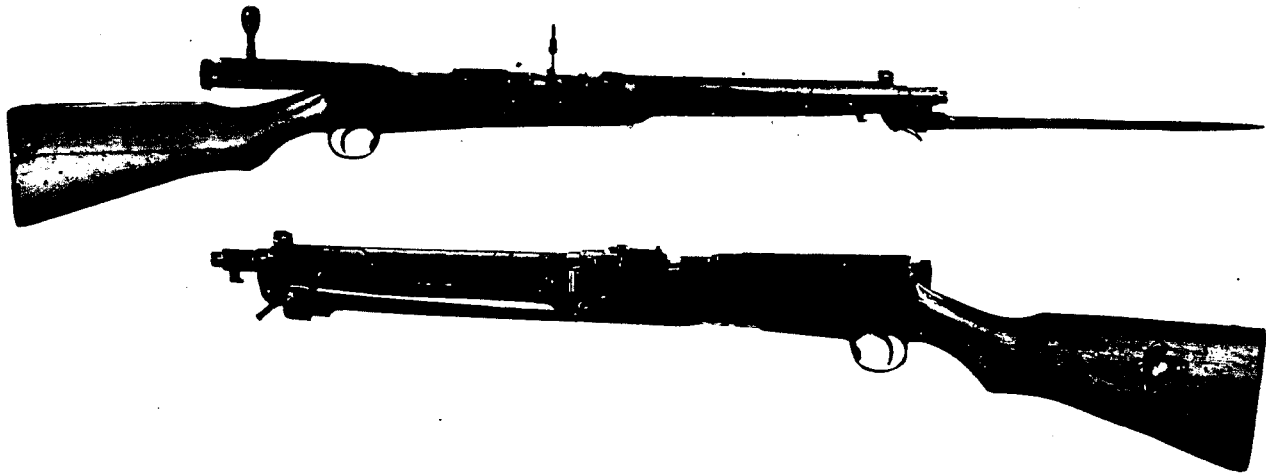

Figure 37. Model 44 (1911) 6.5-mm cavalry carbine.

weapon is the monopod which is used when firing at aircraft from trenches. The bolt is protected with a semicircular, detachable sheet-metal dust cover which slides with the bolt and usually is removed by Japanese soldiers—at least for firing. The safety catch works exactly like that of the Model 38, and the rifle is loaded and unloaded in the same way.

Ammunition is true rimless with a pointed nose. It is usable in the Model 99 light machine gun and the Model 92 heavy

machine gun. A pink ring indicates ball ammunition. Tracer has a green band; armor-piercing, a black band. Paratroopers use a take-down Model 99 (1939) rifle.

Japanese snipers often use a 6.5-mm sniper's rifle which has an over-all length of 50.2 inches. It is fitted with a telescopic sight having a 2½-power magnification and a 10-degree field of view.

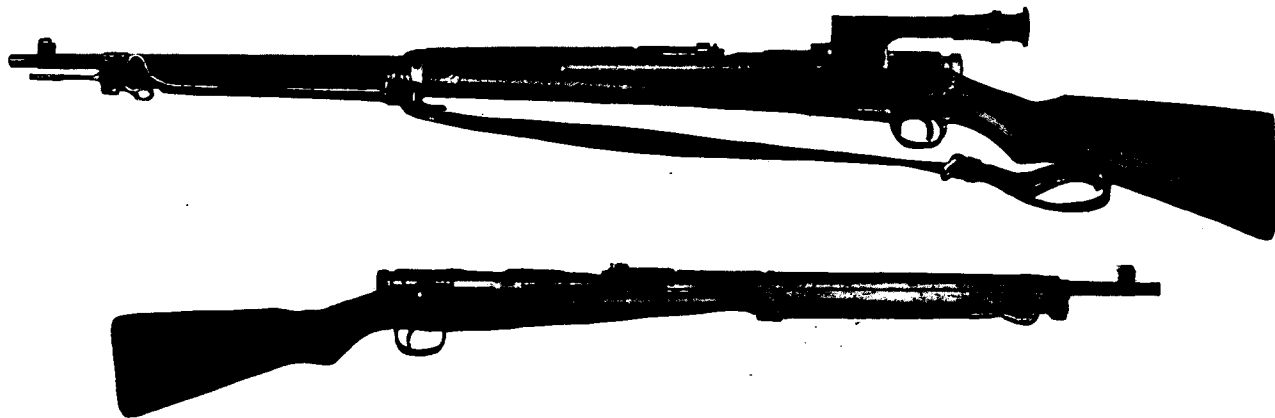

Figure 38. Model 97 (1937) 6.5-mm sniper's rifle (above) and Model 99 (1939) 7.7-mm rifle.

Rifles—Table of Characteristics

Model 38 (1905) 6.5-mm

Caliber.....	0.256 inch
Principle of operation.....	Manually bolt-operated
Ammunition.....	Model 38 (1905) ball and tracer; Model 38 (1905) reduced-charge ball
Capacity of magazine.....	5 rounds
Sight.....	Peep battle sight set for 300 meters (328.1 yards) on rifles of late manufacture
Weight without sling and bayonet.....	9 pounds 4 ounces
Range:	
Effective.....	400 yards
Maximum.....	2,600 yards
Muzzle velocity.....	2,400 feet per second

Model 99 (1939) 7.7-mm

Caliber.....	0.303 inch
Principle of operation.....	Manually bolt-operated
Ammunition.....	Model 99 (1939) rimless ball
Capacity of magazine.....	5 rounds
Sight.....	Folding arms for taking leads in antiaircraft fire; peep battle sight set for 300 meters (328.1 yards)
Weight (unloaded with sling).....	8.8 pounds
Range:	
Effective.....	600 yards
Maximum.....	3,000 yards
Muzzle velocity.....	2,300 feet per second

Grenade Launchers

Both cup- and spigot-type grenade launchers are used with the Model 38 and Model 99 rifles. The cup-type launcher fits over the muzzle and locks over the front sight. From a short, rifled barrel it discharges a hollow-charge

grenade 7.08 inches long and 1.58 inches maximum diameter and containing a bursting charge of 3.81 ounces of TNT. The fuze is not armed until after the grenade has been discharged from the rifle.

The spigot-type is fitted to the rifle like the cup-type and can launch both high-explosive and smoke grenades. It is believed that the grenade is placed over the spigot, the safety pin pulled, and a special wooden bullet fired in the rifle. Setback probably causes the firing pin to strike the percussion cap, activating the delay fuze.

More common is the cup-type Model 100 (1940) launcher designed to fire the Model 99 (1939) (a) antipersonnel hand grenade. It comes in two types, one for the Model 98 6.5-mm rifle and carbine, and one for the Model 99 7.7-mm rifle. Although the types appear to be interchangeable, that for the Model 99 has a vertical white line on the back. The launcher is clamped to the muzzle of the rifle, with cup uppermost and bullet escape tube positioned in front of the rifle bore. It is then locked by running a pin behind the fixed bayonet haud-guard. Ordinary ball propels the grenades about 100 yards (maximum).

Grenades

All Japanese front-line troops carry the Model 97 (1937) hand grenade which cannot be fired from a grenade discharger. It has a black, serrated cast-iron body and a brass fuze. It is loaded with TNT. The time delay is 4 to 5 seconds.

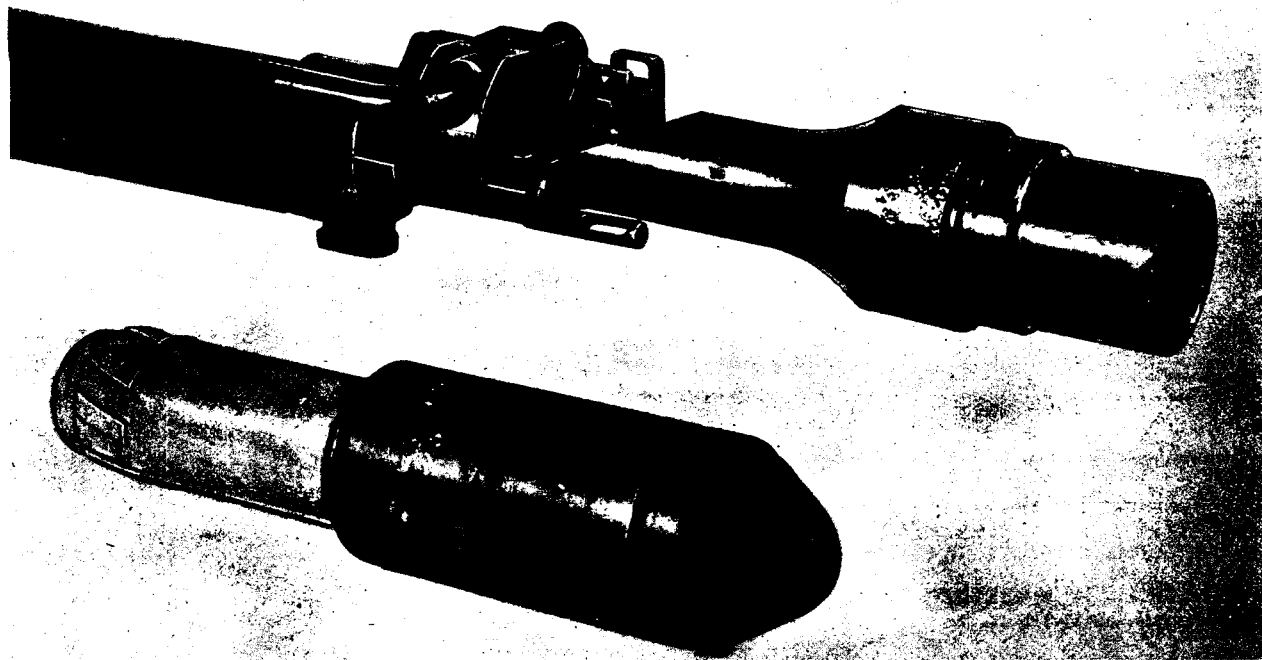

Figure 39. Cup-type grenade launcher and grenade.

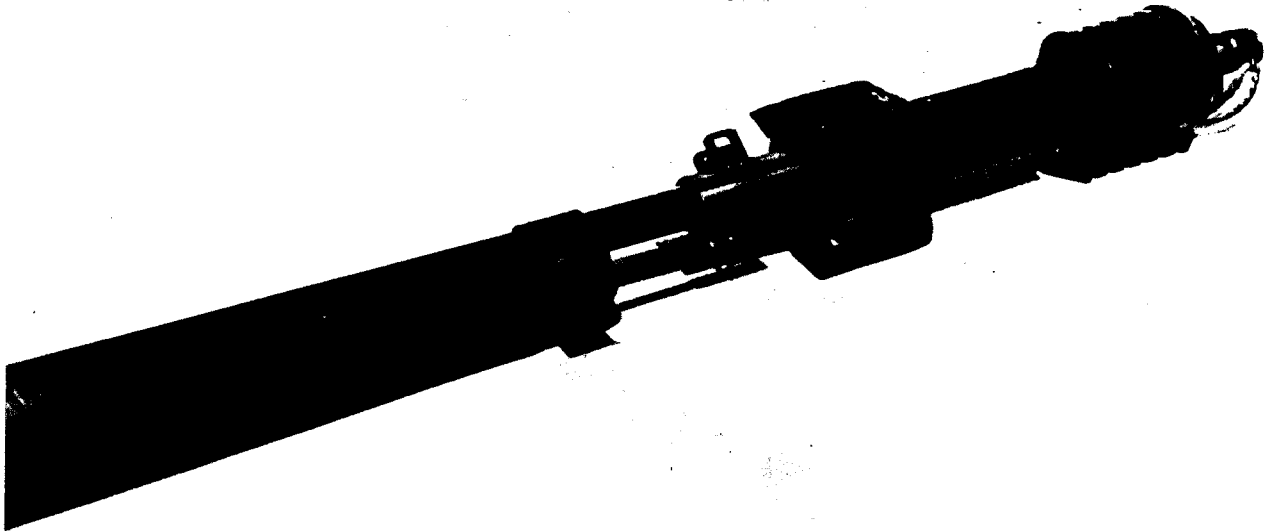

Figure 40. Spigot-type grenade launcher.



Before the grenade is used it is necessary to screw the firing pin down into its holder as far as possible. The grenade then is grasped so that the fuze points downward. Next, the safety pin is withdrawn, after which the head of the fuze cover is struck against some hard object. The grenade then is thrown immediately since the fuze is erratic in timing.

Another widely used grenade is the Model 91 (1931) which can also be fired from 50-mm dischargers Models 10 and 90. It also can be used as a rifle grenade by substituting a tubular tail-fin assembly for the propellant container.

Made of serrated cast-iron and painted black, it is used as a hand grenade in the same manner as Model 97. If fired from a discharger, the safety pin is removed and the grenade is dropped base downward into the discharger. A firing pin hits the percussion cap in the base of the grenade when the trigger mechanism of the discharger is operated. During the acceleration of the grenade in the barrel of the discharger, the firing pin sets back, overcoming the resistance of the creep spring and firing the percussion cap.

During the Kiska operations, Aleutian Islands, the Model 99 (1939) grenade was found in large quantities by U. S. forces. It differs from the other grenades in that it is not serrated. Its time delay is 4 to 5 seconds. It is fired in the same manner as the Model 97 and the Model 91. Both "a" and "b" models are issued, the principal difference being that the "b"

Figure 41. Spigot-type grenade launcher, grenades, and carrying case (left).

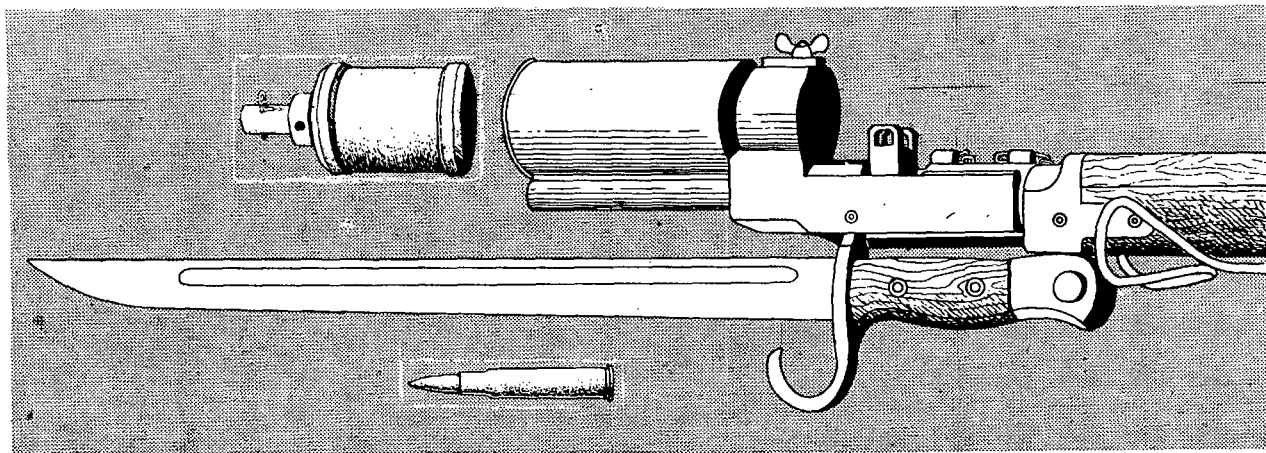

Figure 42. Model 100 (1940) grenade launcher.

cannot be used in the Model 100 (1940) rifle grenade launcher.

The Japanese also use the high-explosive stick hand grenade. It is shaped like a potato masher and is non-serrated. To arm the grenade the metal cap screwed to the end of the wooden handle must be removed. Inside the hollow handle there is a ring attached to the pull cord. The wooden handle is firmly grasped, and the ring is placed over a finger. As the grenade is thrown the ring and cord are retained, and pulling out the

cord activates the friction primer which in turn activates the delaying element.

There is also an incendiary stick hand grenade, easily distinguishable from the high-explosive type by its curved ends. It is filled with phosphorus-impregnated rubber pellets which are scattered by a small bursting charge. A prussic acid gas grenade also has been used.

Grenades—Table of Characteristics

Model 91 (1931) HG

Over-all length.....	4.95 inches
Length without the propellant container.....	3.75 inches
Diameter.....	1.97 inches
Weight.....	18.8 ounces

Model 97 (1937) HG

Over-all length.....	3.75 inches
Diameter.....	1.97 inches
Weight.....	1 pound (approx)

Model 99 (1939) HG

Over-all length.....	3½ inches
Diameter.....	1⅝ inches
Weight.....	10 ounces (approx)

HE Stick HG

Over-all length.....	7.87 inches
Diameter.....	1.97 inches
Weight.....	1 pound 3½ ounces

Grenade Dischargers

Grenade dischargers are designed for use as an individual infantry weapon to bridge the range gap between hand grenades and mortars. For some time these grenade dischargers were erroneously called "knee mortars" but, as a matter of fact, the base plate is made to rest on the ground—not on a soldier's knee or thigh—while the discharger is being fired.

The Model 89 (1929) 50-mm discharger is utilized in

Figure 43. Model 97 (1937) hand grenade.

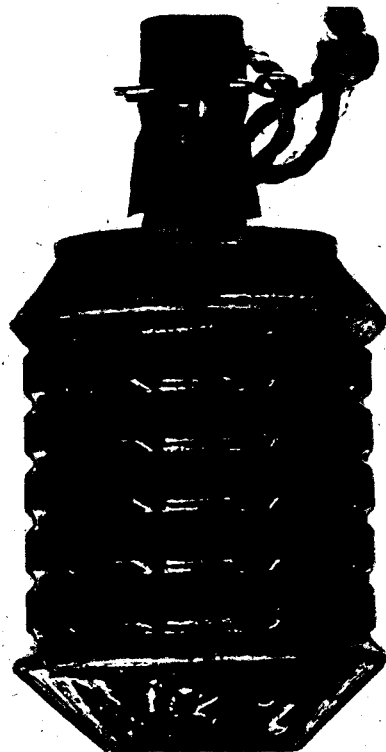

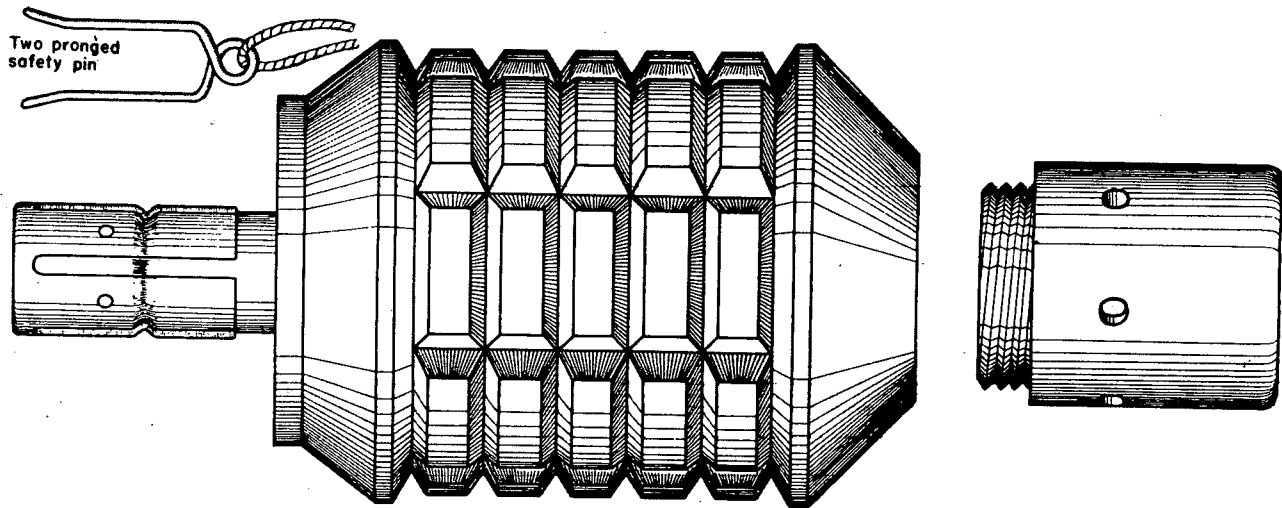
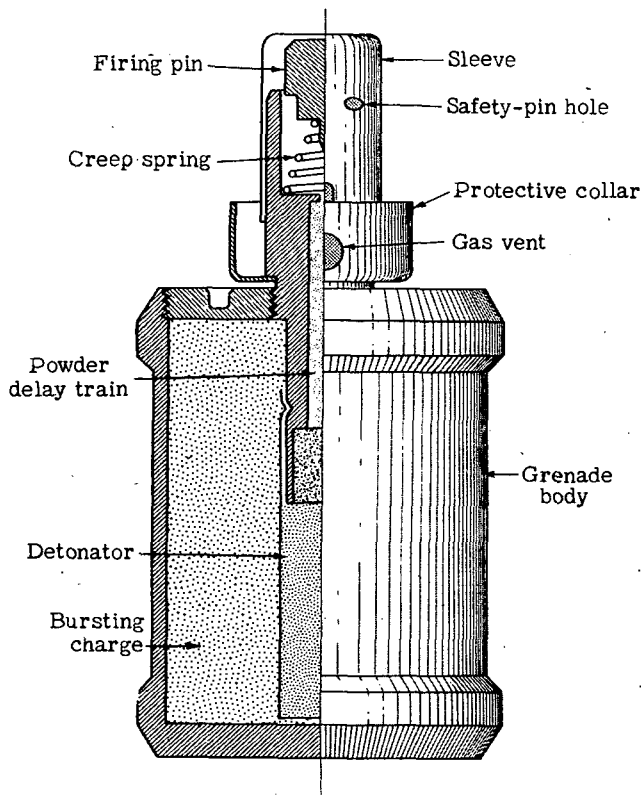

Figure 44. Model 91 (1931) hand grenade.

Japanese infantry tactics to help pin opposing forces to the ground during an attack. Ordinarily three or four such dischargers are issued to the 4th squad of Japanese infantry platoons. The barrel of the discharger is rifled, the firing-pin housing is adjustable, and the weapon is affixed to a concave base plate.

There is no safety device on the weapon. It is set for the desired range by turning the elevator knob which lengthens or shortens the trigger housing extending inside the barrel. Increasing or decreasing the distance traveled by the projectile through the barrel thus regulates the range of the weapon. It is believed that best results are achieved when the discharger



is fired at an angle of 45 degrees. A modified version of the Model 89 found on Attu has a bubble-leveling device to indicate the angle of fire. The Model 89 has no sight, but there is a groove down the barrel for a short distance from the muzzle.

In addition to the Model 89, the Model 10 (1921) discharger is still widely used by the Japanese, but mostly for firing signal ammunition. It differs from the Model 89 in that the barrel is not rifled, and the range is regulated by a gas port rather than an adjustable trigger housing.

Grenade Dischargers—Table of Characteristics

Model 89 (1929) 50-mm GD

Ammunition.....	Model 89 high-explosive shell, Model 91 grenade, Model 95 smoke shell, Model 94 practice shell, etc.
Weight.....	10¼ pounds
Weight of Model 89 shell.....	1 pound 12 ounces

Model 10 (1921) 50-mm GD

Ammunition.....	Model 91 grenade, Model 11 smoke shell, Model 10 flare shell, Model 10 signal shell, Model 91 practice grenade, Model 10 blank shell, etc.
Weight.....	5¼ pounds
Range of Model 91 grenade.....	65 to 175 yards
Barrel.....	Smooth bore

Figure 45. Model 99 (1939) "Kiska" hand grenade.

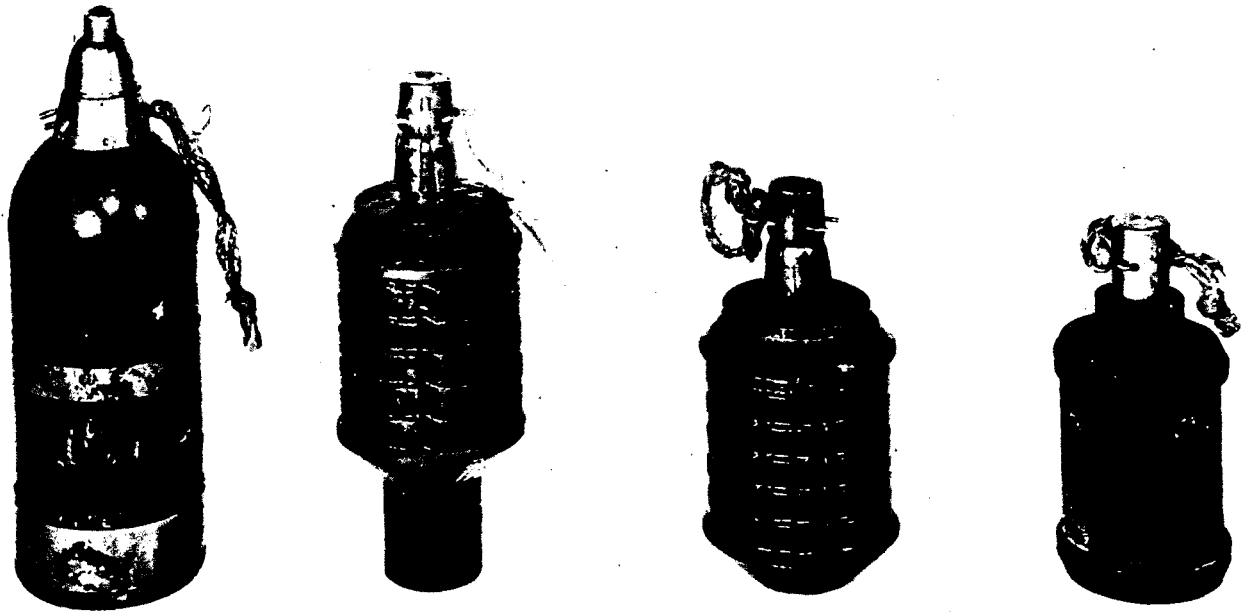
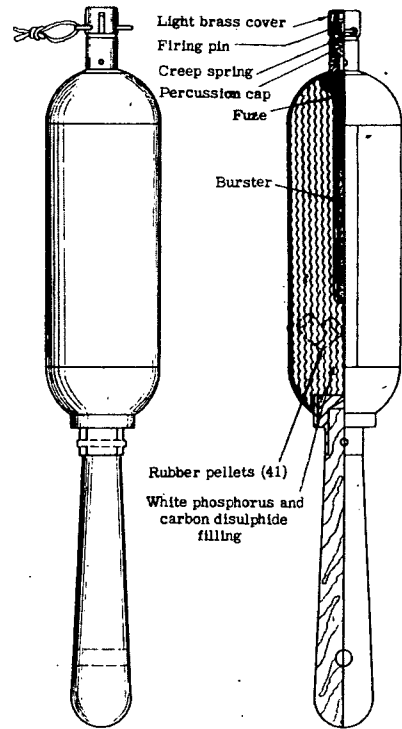
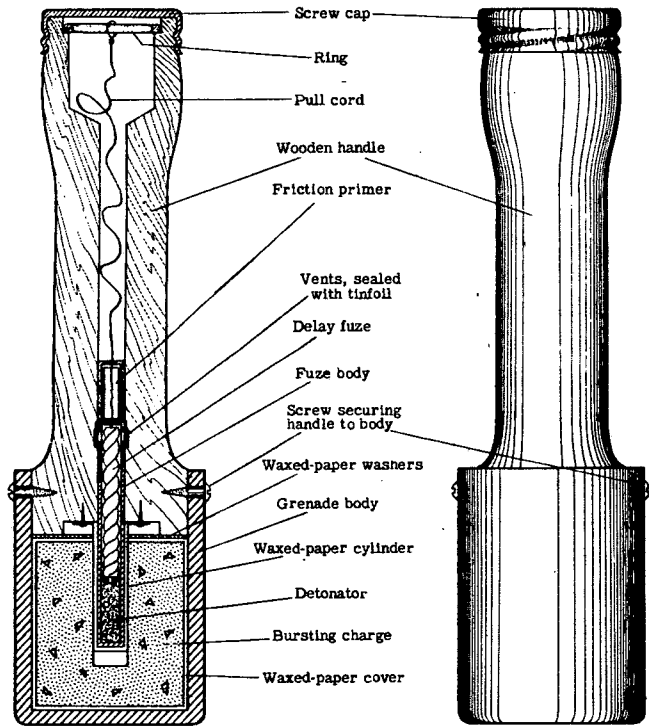

Figure 46. Left to right: Model 89 (1929) shell, Model 91 (1931) hand grenade, Model 97 (1937) hand grenade, Model 99 (1939) grenade.



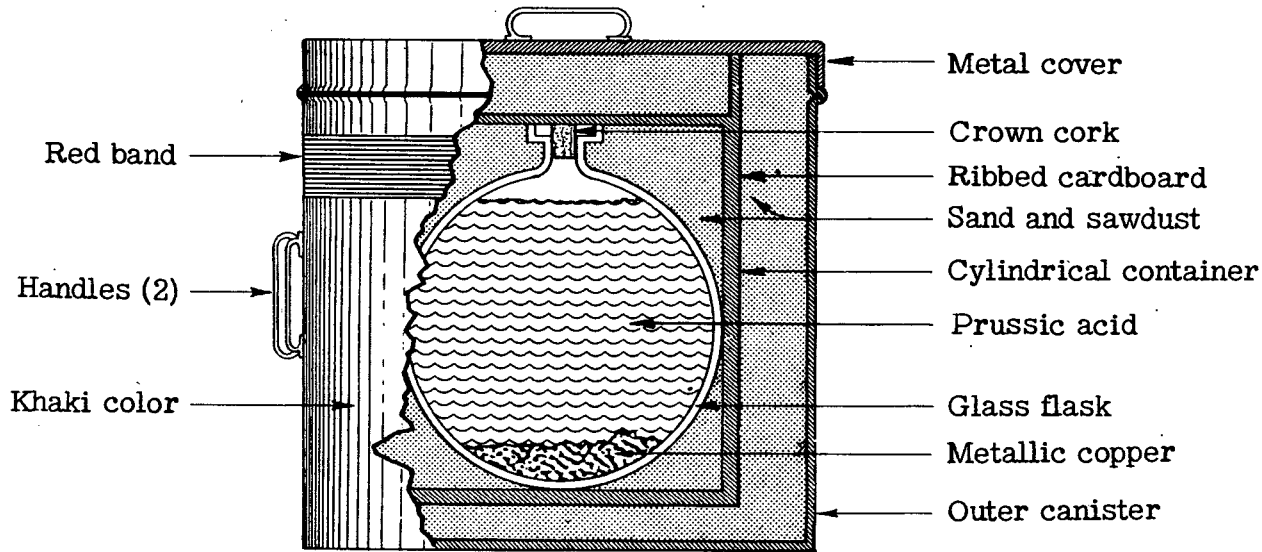

Figure 49. Prussic acid gas grenade.

Figure 47. Stick grenade (left).

Figure 48. Incendiary stick hand grenade (right).

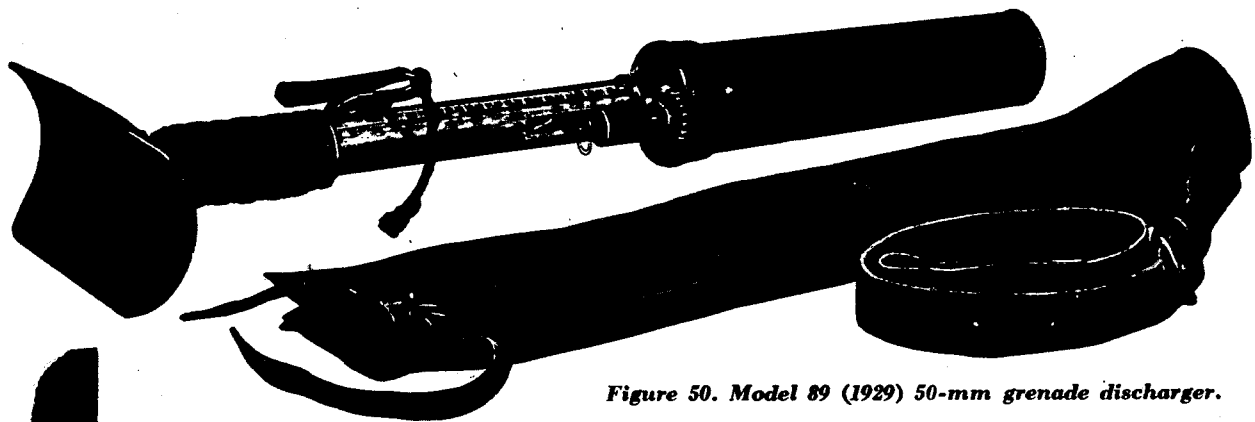

Figure 50. Model 89 (1929) 50-mm grenade discharger.

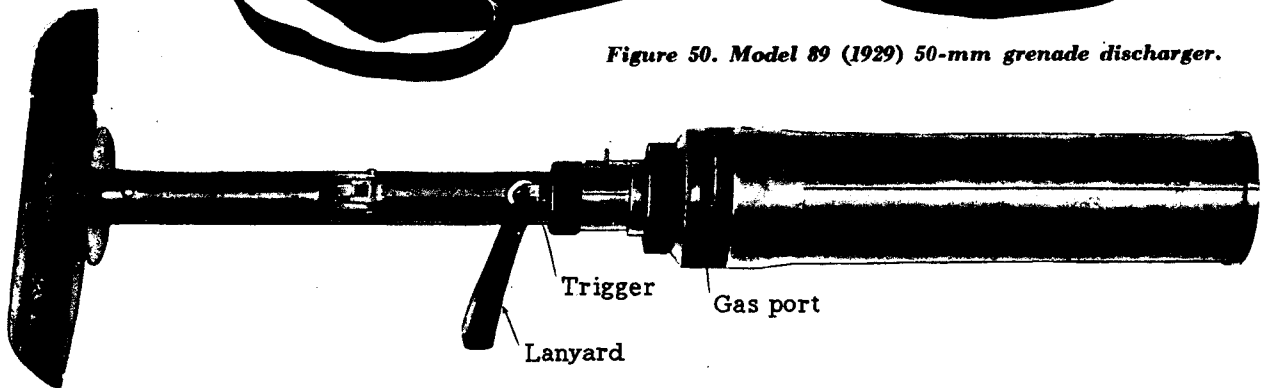

Figure 51. Model 10 (1921) 50-mm grenade discharger.

Machine Guns

The Model 11 (1922) 6.5-mm light machine gun has been standard equipment in the Japanese infantry squad. An unusual feature of the gun is the fact that it is fed by six 5-round clips of ammunition. Note that it fires only reduced-charge rifle cartridges and will *not* function properly with other types. It is used on a bipod mount as a light machine gun; as a combination heavy machine gun and anti-aircraft gun it occasionally is mounted on a tripod. The gun is gas-operated and air-cooled. Ammunition is loaded through the feed hopper attached to the left side of the receiver. Prominent identification characteristics are the feed hopper, the cut-out shoulder stock, and the front and rear sights offset to the right.

The safety lever is on the left of the trigger guard; it is shifted downward until approximately vertical to be on the "safe" setting. To disengage the safety, the lever is pulled backward and upward until in a horizontal position.

To fire the gun, the follower of the feed hopper is raised to permit horizontal insertion of six clips. The follower then is permitted to snap back in place. Next the gun is cocked by pulling back the operating handle on the left until the extension of the piston engages the sear notch. The handle then is pushed forward until its catch clips into the receiver. Rate of fire is adjusted by a gas regulator with several openings of different sizes. The gun is unloaded by pulling back on the knurled feed-housing lock on the feed-housing assembly, and removing the assembly to the left. Ammunition then is removed from the feed well of the feed-housing assembly. No

attempt should be made to unload the gun by working live rounds through it, because it fires from an open bolt and will fire when the bolt closes and locks.

The Japanese make considerable use of the Model 92 (1932) 7.7-mm Lewis-type machine gun. This weapon is a duplicate of the British model except for the fact that the cocking handle is on the left side and cannot be shifted to the right side of the gun. An advantage of the Lewis-type weapon is the fact that, without removing the gun from its mount, it can be adapted for anti-aircraft use in about 15 seconds.

The Japanese Model 96 (1936) 6.5-mm light machine gun is very similar in appearance to the British Bren light machine gun, caliber .303. In construction, however, it embodies certain features of French and Czech automatic weapons. With a mechanism that represents a considerable improvement upon the Model 11, it handles well and can be fired from the hip.

Prominent identification features are the carrying handle directly in front of the receiver, the operating handle on the left of the receiver, the drum-controlled rear peep sight, and the quick-change barrel with the swinging-arm release catch.

The gun is gas-operated and air-cooled. A spare barrel is carried as a replacement should a change be necessary. The gun is fed by a curved-box magazine containing 30 rounds which is placed on top of the receiver. The safety is located on the left side of the trigger housing in front of and above the trigger. In horizontal position, it is set to "fire"; when it is in the vertical position, the gun is locked.

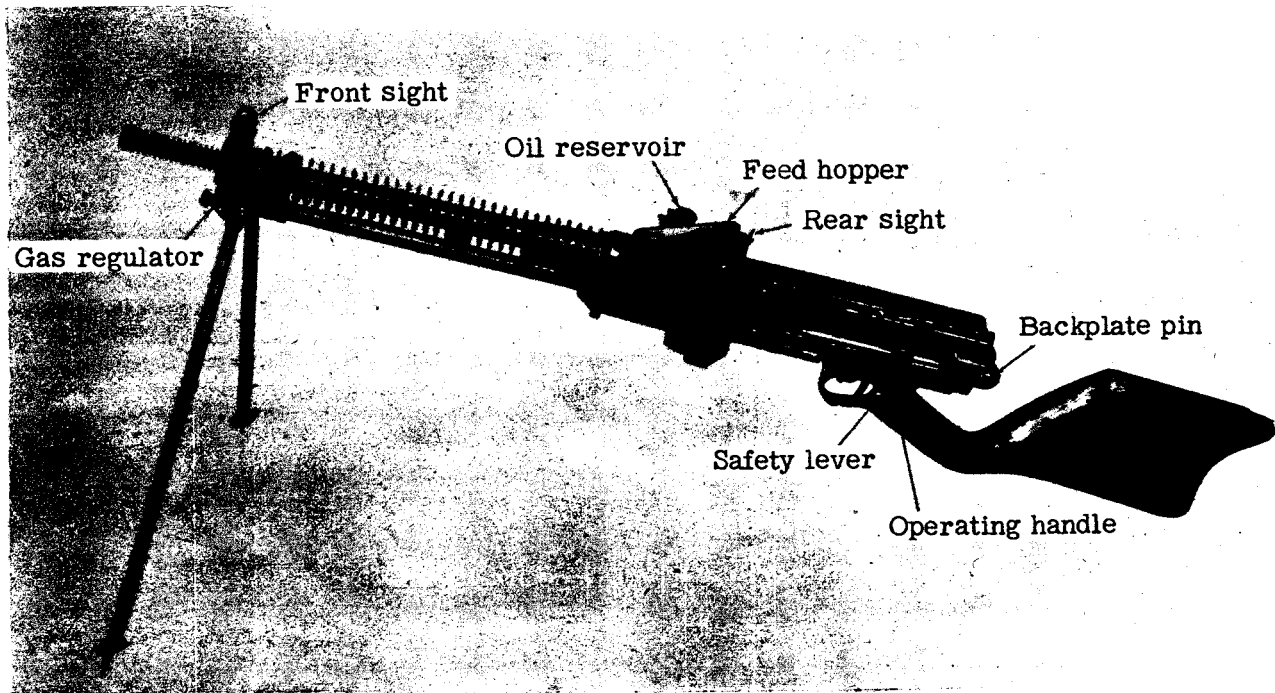

Figure 52. Model 11 (1922) 6.5-mm light machine gun.



To load the gun, a 30-round magazine is inserted into the opening in the top of the receiver, catching the front side of the magazine first and pulling it back until the catch on the back of the magazine opening engages the magazine. The operating handle then is pulled to the rear until the sear engages the operating slide. The operating handle is then returned to its forward position and, after the range is set on the sight drum, the gun is ready for firing.

The gas-piston plug has five positions, enabling the size of the gas port to be increased as the plug is turned from 1 toward 5. A large opening increases the recoil; a smaller opening will diminish it.

To unload the gun, the magazine catch is pressed forward with the base of the palm of the hand. The magazine then is grasped and tilted forward until clear of the magazine catch, after which it can be lifted off.

As in the case of the Model 99 rifle, adoption of the Model 99 (1939) 7.7-mm light machine gun is additional evidence of the trend in the Japanese Army toward the use of heavier infantry weapons with some sacrifice of mobility.

The Model 99 light machine gun is quite similar in appearance to the Model 96. However, there are several easily recognized distinguishing features. The Model 99 has an adjustable rear monopod. Also, the Model 99 has the nut-and-wedge type barrel release, whereas the Model 96 has a pivot-

Figure 53. Feed hopper of Model 11 (1922) 6.5-mm light machine gun.

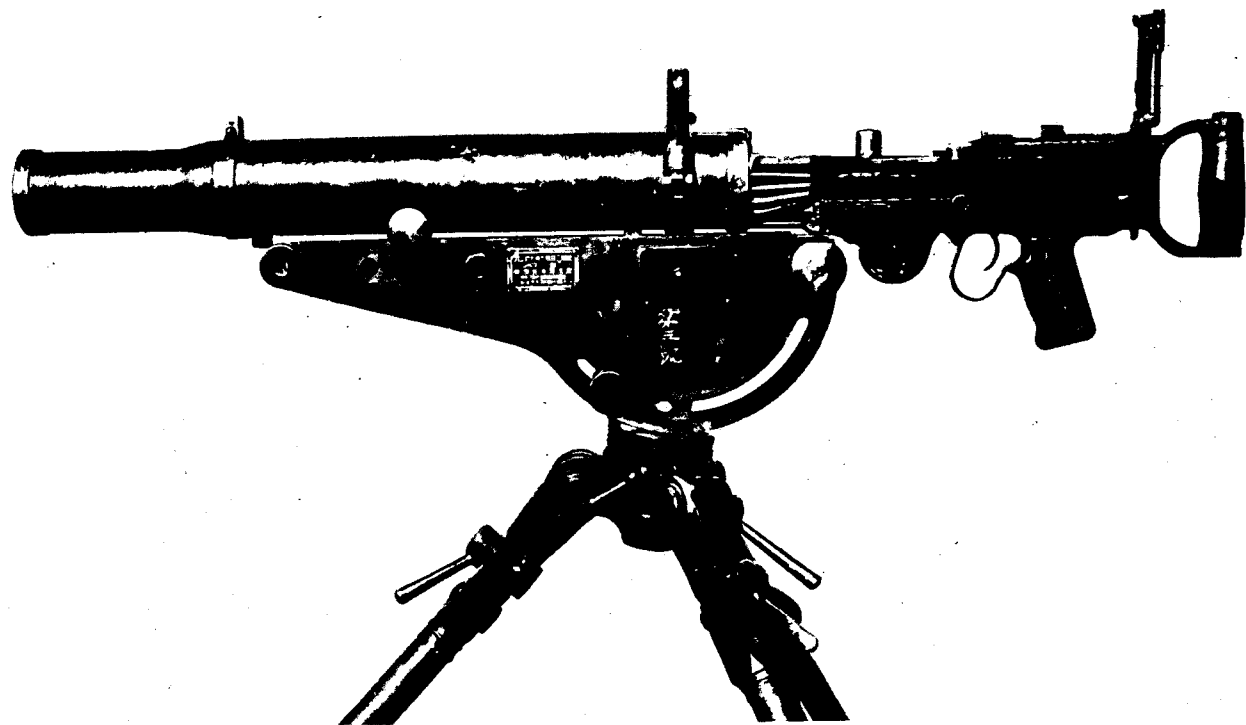

Figure 54. Model 92 (1932) 7.7-mm Lewis type light machine gun.



Figure 55. Model 96 (1936) 6.5-mm light machine gun.

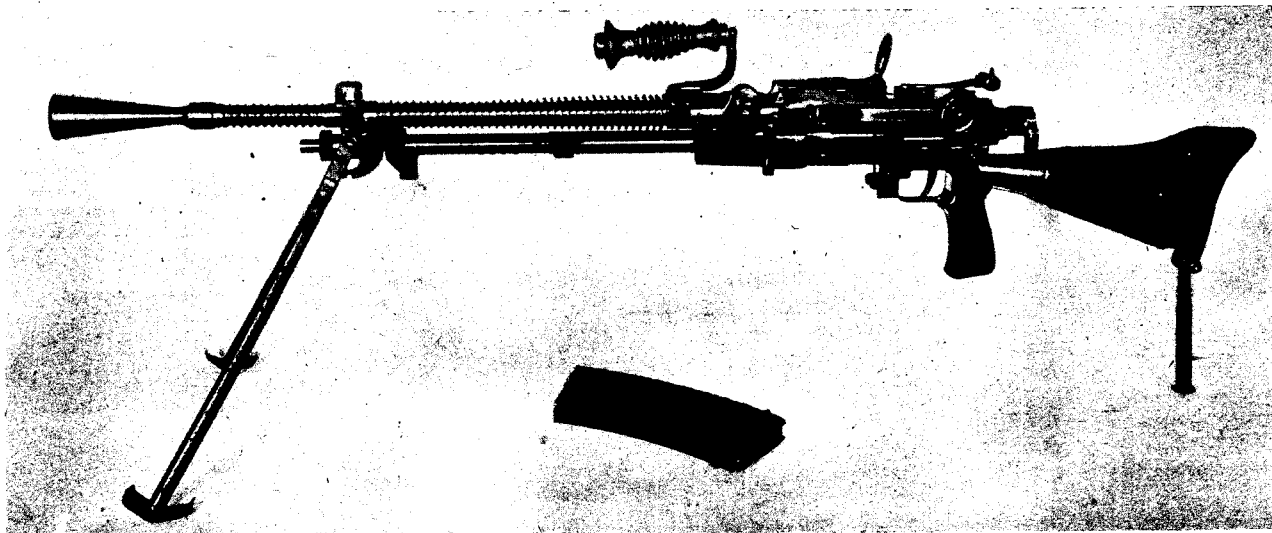

Figure 56. Model 99 (1939) 7.7-mm light machine gun.

ing, barrel-locking knob. The flash hider of the Model 99 is screwed onto the muzzle; that of the Model 96 has a bayonet-type locking device.

The Model 99 is gas-operated, air-cooled, and magazine-fed. Both front bipod and rear monopod are used in firing, with elevation of the piece changed by adjustments of the monopod.

Ammunition is fed from a 30-round, curved-hox magazine which fits into the top of the receiver. An important point to note is the fact that many parts are common to both Models 96 and 99, and their mechanisms are practically identical.

In operating the Model 99, the safety lever on the right or left side of the receiver is rotated downward to the horizontal

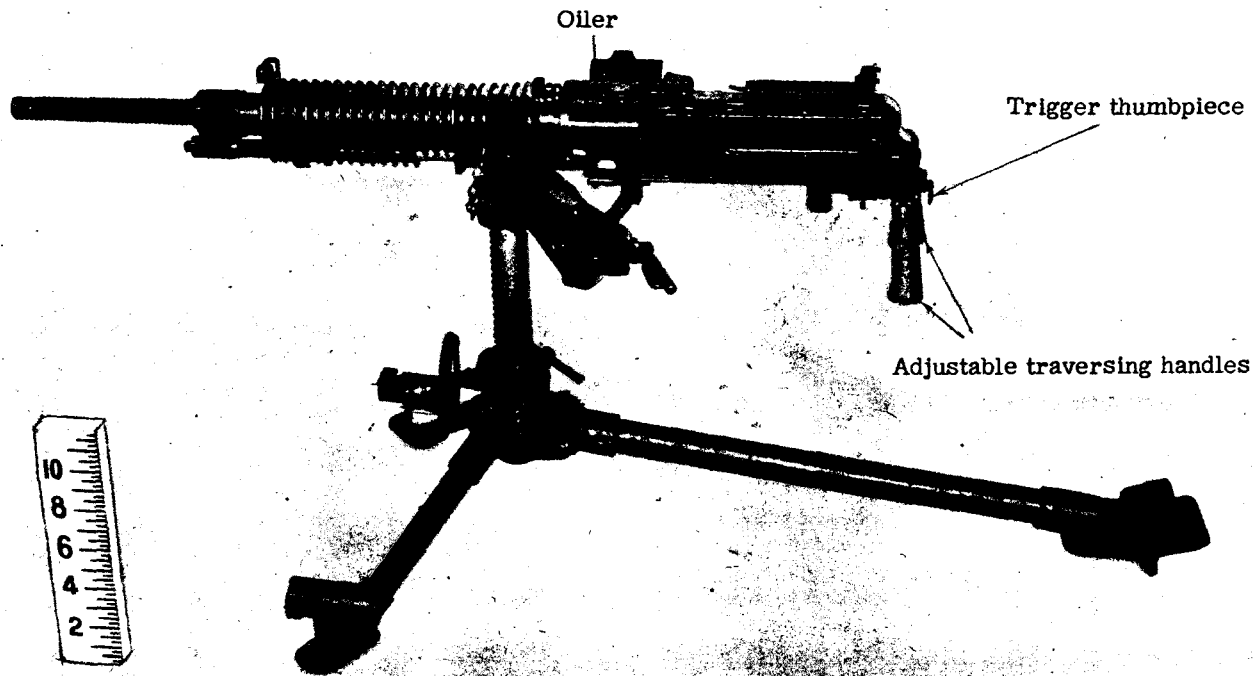

Figure 57. Model 92 (1932) 7.7-mm heavy machine gun.

position. The magazine- and ejection-port covers are then opened. Next, the loaded magazine is inserted, with the inside curve to the front. The front end of the magazine must be engaged in the receiver first, after which the magazine can be pressed down until its catch engages the rear flange in the receiver opening. The operating handle is then pulled to the rear as far as possible and pushed forward again. After the sights are set by turning the elevating drum to the desired range, the gun is ready for firing. It will fire as long as the trigger is pulled. It cannot be used as a semiautomatic weapon. The rate of fire is regulated in the same manner as on the Model 96. Ammunition used is the Model 99 (1939) 7.7-mm true rimless type.

The only Japanese-manufactured submachine gun is the Model 100 (1940), which fires 8-mm pistol ammunition. It is an air-cooled weapon designed to take a bayonet. It is fitted with a bipod and is said to have a folding stock. Though previously noted in Manchuria, the Model 100 so far has been identified only on Saipan.

The standard, most commonly used Japanese 7.7-mm heavy machine gun is the Model 92 (1932) which normally is mounted on a tripod and can be adapted for antiaircraft use. Prominent identification characteristics are large radiating rings, adjustable traversing handles, the cocking handle mounted on the right side, and the oiler which is located above and to the left of the receiver, directly above the feedway.

A modified Hotchkiss type, the Model 92 seldom overheats because of its slow rate of fire, and therefore the life of the

barrel is unusually long. The weapon is gas-operated and full automatic only. The base of the receiver has a mount for a telescopic sight.

Turning the trigger thumbpiece clockwise puts the gun in the "safe" position. The feed strip then can be removed, and the bolt is locked. Inserting a feed strip unlocks the bolt, and the gun can be put in the "fire" condition by pressing on the trigger thumbpiece.

To fire the piece, the traversing handles are put into the lower, or firing, position. The cocking handle then is pulled back and pushed forward again. Both feed and ejection openings will open automatically when the cocking handle is moved. Ammunition is inserted from the left side of the feed mechanism with the rounds uppermost. To unload, the feed holding-pawl arm hook underneath the feedway (on the left side of the receiver) is pulled out. The gun will continue to fire, until the ammunition is expended, as long as the trigger thumbpiece is pressed forward. Rate-of-fire adjustment is made by screwing the gas-cylinder plug in or out until the gun functions as desired.

Three telescopic sights are available for use with the Model 92. The Models 93 and 94 are both of the periscopic type. The former is six-power, and the latter five-power. The Model 93, which measures 8.4 inches, is used only to lay the gun. The Model 94, which is 12.8 inches from top to bottom, has an eyepiece on level with the top of the receiver. The Model 96 (1936) telescopic sight, which is four-power, may be used while the gun is firing.

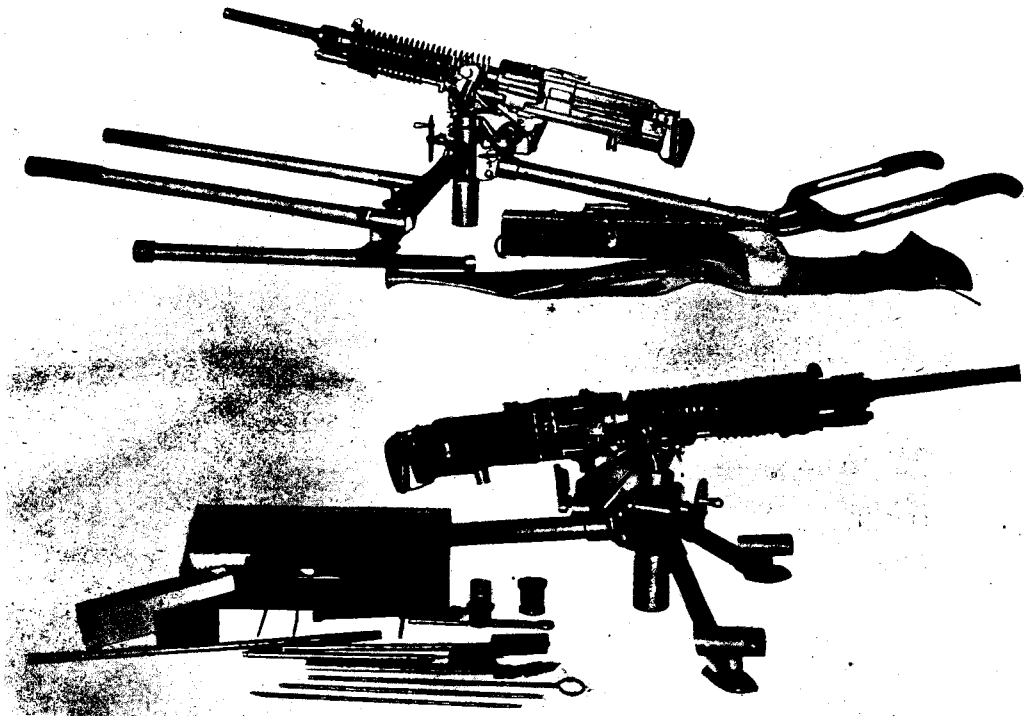

Figure 58. Model 3 (1914) 6.5-mm heavy machine gun.

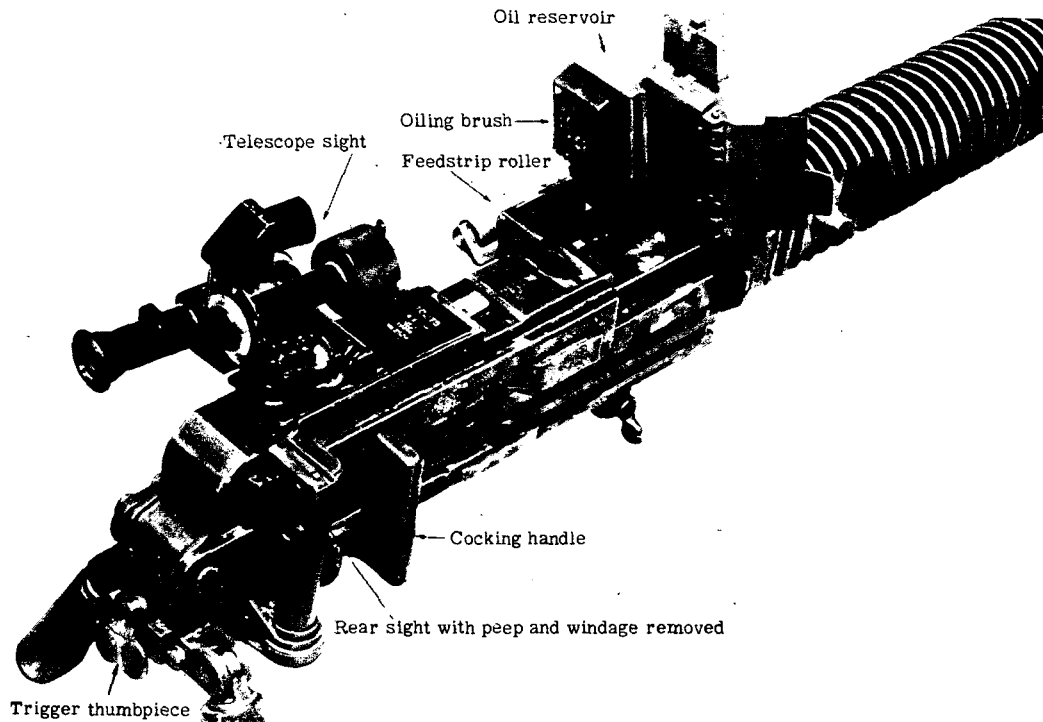

Figure 59. Details of sights of Model 92 (1932) 7.7-mm heavy machine gun.

The Model 92 heavy machine gun uses the 7.7-mm semi-rimmed ammunition in ball, tracer, or armor-piercing forms. Model 99 (1939) rimless 7.7-mm also can be fired in this gun, if loaded in 30-round feed strips.

The Japanese use the Model 93 (1933) 13-mm heavy machine gun for both antiaircraft and ground fire. A single-barreled version of the weapon exists, with a different mount than is employed in the double-barreled model. The two guns on the Model 93 double-barreled weapon are mounted separately and can be stripped from the mount individually. There is an iron chair for the gunner who operates each of the guns with separate pedals.

There is no safety device on the gun. Each gun is cocked individually by pulling back the respective cocking handles on the sides of the receivers. The loaded magazines (with 20 rounds to each box-type magazine) are put on, and the guns fired by pressing the pedals. Ball, armor-piercing, and tracer ammunition are used. A black band on the outer edge of the primer denotes ball ammunition. White bands and red bands indicate armor-piercing and tracer, respectively.

Machine Guns—Table of Characteristics

Model 11 (1922) 6.5-mm light MG

Caliber.....	0.256 inch
Principle of operation.....	Gas-operated, full-automatic only
Ammunition.....	Model 38 (1905) semirimmed, reduced-charge cartridges in 5-round clips
Type of feed.....	Hopper
Weight.....	22½ pounds

Range:	
Effective.....	1,640 yards
Maximum.....	4,374 yards
Muzzle velocity.....	2,440 feet per second
Rate of fire:	
Effective.....	150 rounds per minute in 5-round bursts
Cyclic (maximum).....	500 rounds per minute

Model 96 (1936) 6.5-mm light MG

Caliber.....	0.256 inch
Principle of operation.....	Gas-operated, full-automatic only
Ammunition.....	Model 38 (1905) semirimmed reduced-charge
Type of feed.....	30-round box magazine
Weight with sling.....	20 pounds
Range:	
Effective.....	1,640 yards
Maximum.....	4,374 yards
Muzzle velocity.....	2,410 feet per second
Rate of fire (cyclic).....	550 rounds per minute

Model 99 (1939) 7.7-mm light MG

Caliber.....	0.303 inch
Principle of operation.....	Gas-operated, full-automatic only
Ammunition.....	Model 99 (1939) 7.7-mm rimless cartridge only. Use of ball cartridges is known, but no reports of armor-piercing or tracer cartridges have been received
Type of feed.....	30-round box magazine
Weight without magazine.....	20 pounds
Range:	
Effective.....	1,500 yards
Maximum.....	3,800 yards
Muzzle velocity.....	2,300 feet per second
Rate of fire:	
Effective.....	250 rounds per minute
Cyclic.....	800 rounds per minute

Model 92 (1932) 7.7-mm heavy MG

Caliber.....	0.303 inch
Principle of operation.....	Gas-operated, full-automatic only



Ammunition.....	Ball, tracer, and armor-piercing both semirimmed and rimless ammunition can be fired
Type of feed.....	Strips (30 rounds each)
Weight:	
Without tripod.....	61 pounds
With tripod.....	122 pounds
Traverse (with tripod mount).....	360 degrees (33.5 degrees on an arc)
Elevation (with tripod mount):	
Maximum.....	11 degrees
Minimum.....	-15 degrees
Range:	
Effective.....	1,500 yards
Maximum.....	4,587 yards
Muzzle velocity (with Model 92 (1932) ball ammunition).....	2,400 feet per second
Rate of fire:	
Effective.....	200 rounds per minute
Cyclic.....	450 rounds per minute

Model 93 (1933) 13-mm twin heavy MG

Caliber.....	0.519 inch
Principle of operation.....	Gas-operated, full-automatic only
Ammunition.....	Ball, tracer, and armor-piercing
Total weight of each gun.....	87 pounds
Muzzle velocity:	
Ball ammunition.....	2,210 feet per second
Armor-piercing ammunition.....	2,280 feet per second

Model 100 (1940) 8-mm SMG

Caliber.....	8-mm
Principle of operation.....	Blowback
Ammunition.....	8-mm Namhu (pistol) cartridges
Type of feed.....	30-round curved box magazine under receiver
Weight (with bipod).....	(Not yet ascertained)
Muzzle velocity.....	1,082 feet per second
Rate of fire (cyclic).....	700

Figure 60. Model 93 (1933) 13-mm heavy machine gun (single mount).



Mortars

Mortars are used most effectively by the Japanese Army, and their performance seems to be fully up to the standard of other modern armies. The Model 98 (1938) 50-mm mortar has three main parts—the base plate, the bipod, and the barrel. Its elevation is fixed at about 40 degrees, but provision is made for limited traverse by loosening the two wing nuts that secure the bipod and swinging the bipod feet on the arc.

The Model 98 50-mm weapon fires a formidable stick bomb which weighs nearly 10 pounds and contains about 7 pounds of explosive charge. To fire the weapon it is first necessary to insert one or more powder increments into the muzzle. The stick of the bomb then is placed in the tube. Adjustment of the graduated range slide, which is clamped to the muzzle, will regulate the distance the stick will go into the barrel. The greater the distance the stick extends into the barrel, the greater the range that will be attained.

The explosive charge of the bomb is armed by insertion of two friction-type pull igniters in the holes in the base of the charge. Each igniter is connected by cord to one of the two links extending from the barrel collar of the mortar on each side. A pull-type friction primer then is inserted into the primer seat on the side of the barrel near the base. Pulling the loop lanyard attached to this friction primer fires the piece.

The Model 11 (1922) 70-mm mortar is muzzle-loaded, but

Figure 61. Model 93 (1933) 13-mm heavy machine gun (dual mount).

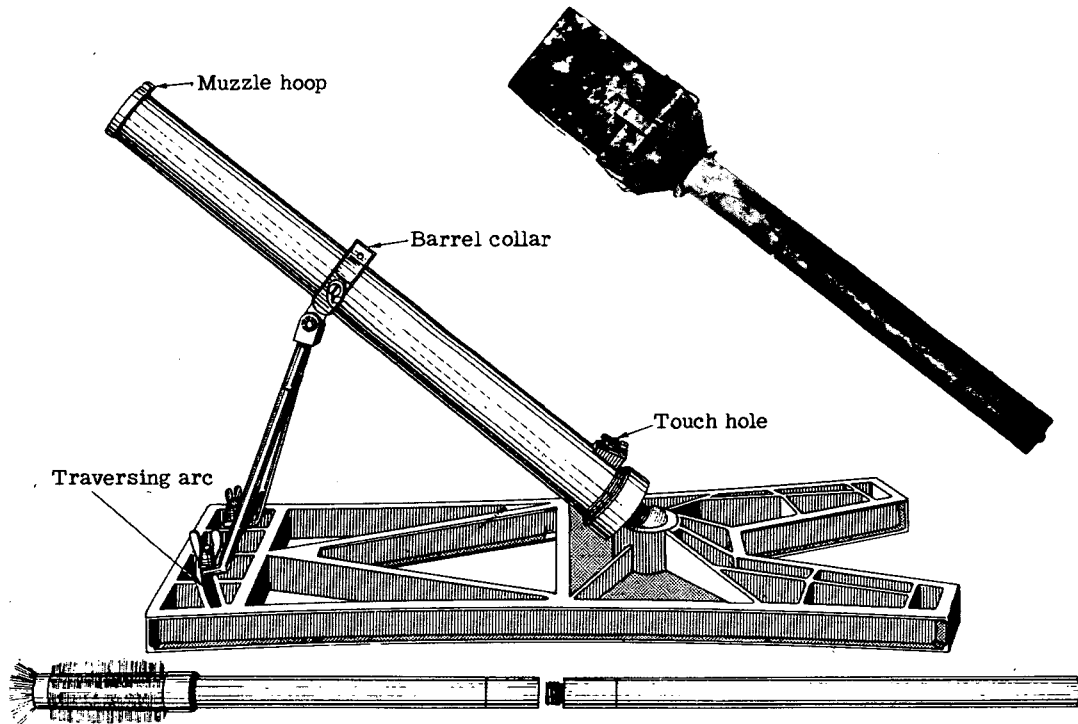

Figure 62. Model 98 (1938) 50-mm mortar and stick bomb.

nonetheless it has a rifled bore. It is mounted on a wooden base plate, and the barrel is supported by an adjustable elevating screw. Laying-in is done with the aid of a gunner's quadrant which has an elevation scale graduated in half-degrees from 0 to 55 degrees, used in conjunction with a Vernier arm which permits corrections to one-sixteenth of a degree. The quadrant also contains a leveling vial.

When the piece is properly laid-in by use of the elevating screw and the traverse wheel, the shell is placed down the barrel and the mortar fired by means of a lanyard attached to a striker arm. For safety all crew members should crouch below the level of the muzzle when the piece is fired.

The mortar fires a high-explosive shell made up of a fuze, the body, and the propelling-charge assembly. The fuze is a simple point-detonating type. The steel shell body is threaded at the top and bottom to receive the fuze and propelling-charge assembly respectively. The propelling-charge assembly consists of the percussion cap, the propellant, and a copper rotating band which is engaged by the rifling.

The simplest mortar design used by the Japanese is the 70-mm barrage mortar, first encountered during the Attu operations. The barrel is smooth-bored and is attached to a wooden base by means of a base plate. A spike extension rod on the bottom of the base is used to anchor the piece into the ground. The wooden base absorbs the shock of firing and prevents the mortar from "digging in." Changes in elevation are made by altering the angle at which the rod is pegged into the ground. The mortar is fired simply by dropping the shell down

the muzzle, propelling charge first.

After the shell is propelled, a time train and fixed powder charge cause the projection of seven smaller bombs borne by rice-paper parachutes. A larger parachute opens at the same time, tilting the main container and insuring the scattering of the seven small bombs. These are loaded with nitrostarch and are detonated in the air by a pull-igniter fuze which has a phosphorus-coated string and delay element.

The Model 97 (1937) 81-mm mortar is almost identical with the U. S. 81-mm mortar M1. There are two minor differences, however, for the Japanese weapon has an offset locking nut for the firing pin and buttress-type thread on the elevating and traversing screws. Operation is identical with that of the U. S. piece, and the ammunition is so similar in every respect that it can be used interchangeably.

The Model 99 (1939) 81-mm mortar also is similar to the U. S. 81-mm mortar M1, except that it has a shorter barrel, is equipped for trigger firing, and has a close fit between the bore and the projectile to compensate for the shorter barrel. Two men can carry the Japanese weapon, which can also be transported by horsecart or motor truck.

In the barrel collar of the Model 99 there is a buffer system to absorb part of the recoil by the action of two recoil cylinders filled with light grease or heavy oil. The weapon normally is used with a collimator sight, that is, one which adjusts the line of sight relative to other parts of the mortar; but a gunner's quadrant can be mounted, and a white line painted along the top of the barrel also aids in sighting.

Figure 63. Model 11 (1922) 70-mm infantry mortar.

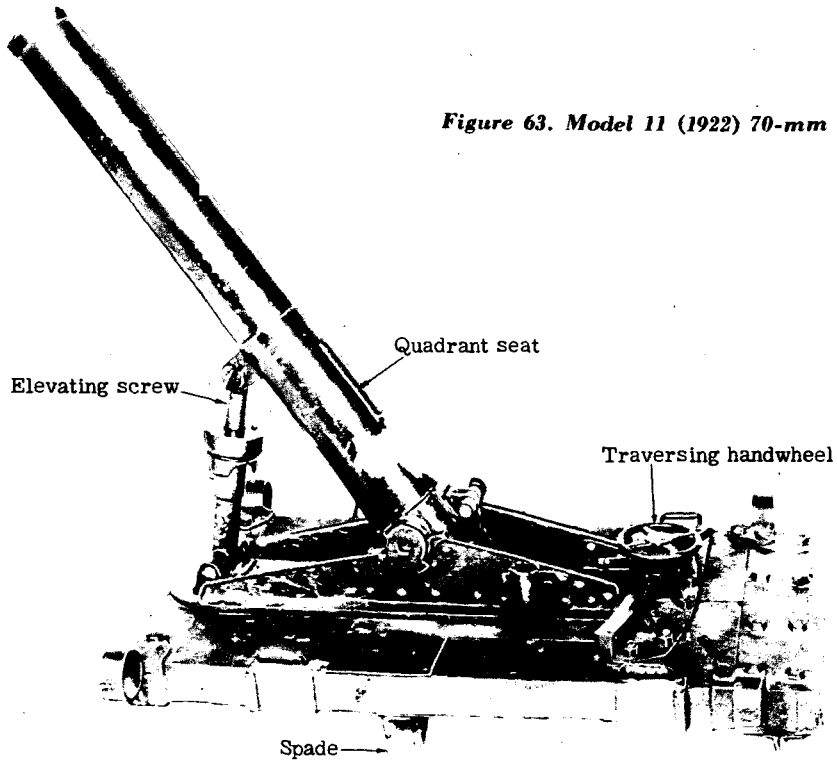

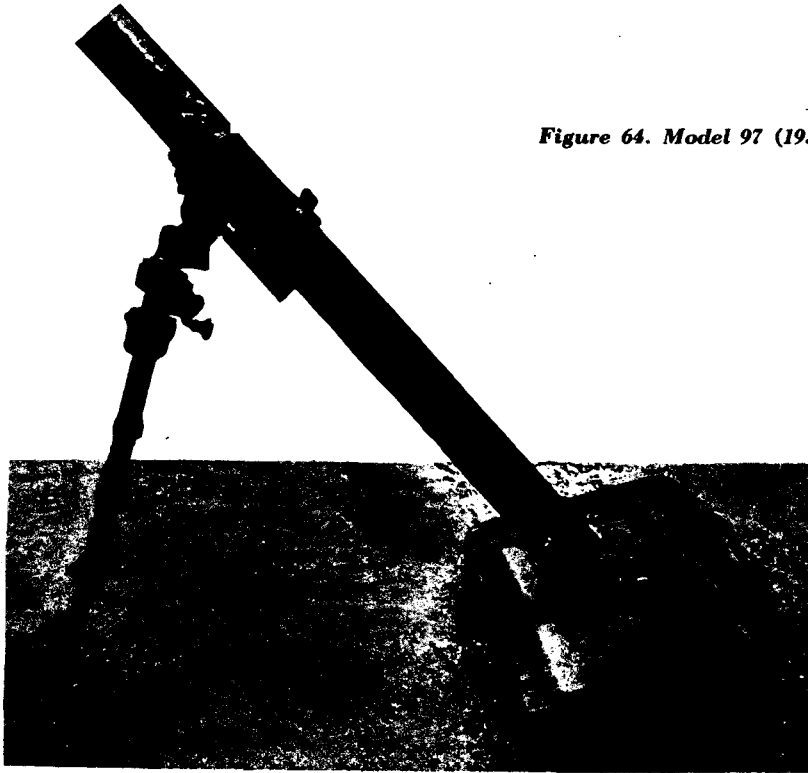
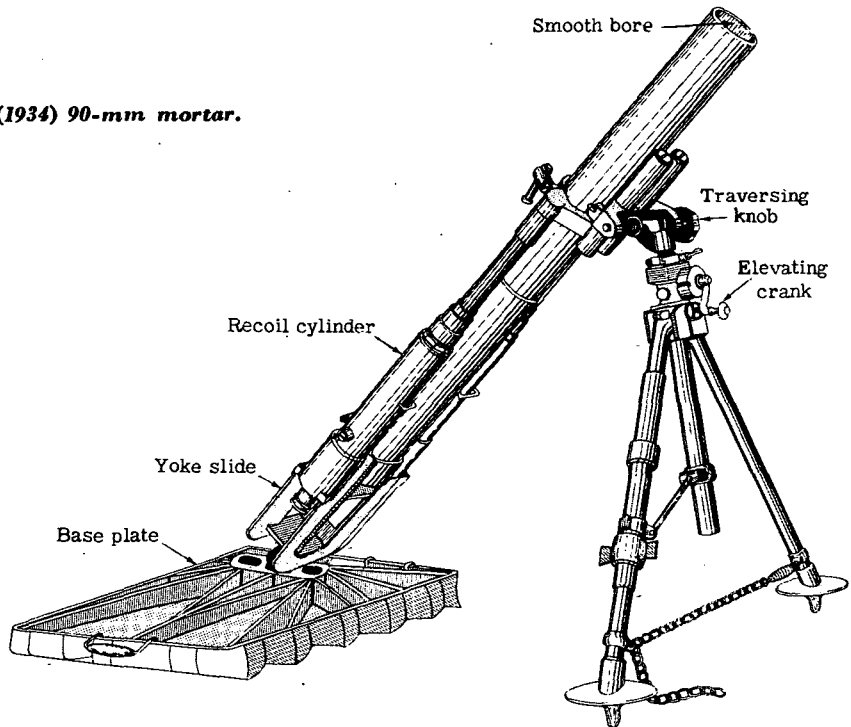

Figure 64. Model 97 (1937) 81-mm mortar.



*Figure 65. Model 99 (1939)
81-mm mortar.*

Figure 66. Model 94 (1934) 90-mm mortar.



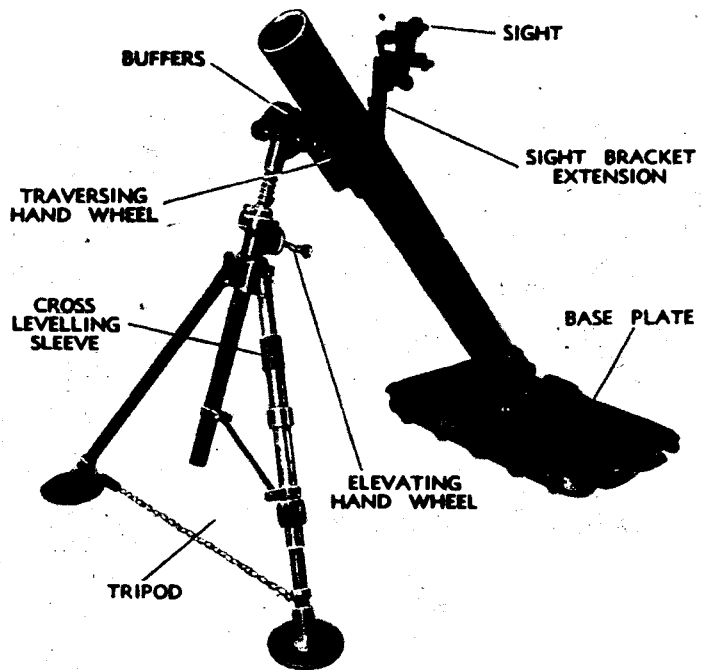

*Figure 67. Model 97 (1937)
90-mm mortar.*

There is a safety lever at the side of the base cap at the base of the mortar barrel. When this lever is turned to the left the firing pin is in firing position. When the piece has been laid-in the shell is placed fin-first in the muzzle and permitted to slide down the barrel. The firing-pin shaft is then struck with a wooden mallet. The blow drives the firing-pin shaft into the base cap, jamming the firing pin upward into contact with the cartridge primer. All members of the crew should crouch or lie on the ground when these firing steps have been completed. Both high-explosive and smoke or chemical shells are used, and there are two weights—7.2 pounds and 14.3 pounds.

One of the largest Japanese infantry mortars commonly used is the 90-mm Model 94 (1934). It is a smooth-bore, muzzle-loading weapon with a fixed firing pin. It is equipped with two recoil cylinders mounted on a one-piece U-shaped frame. This frame fits into the base plate by a ball-and-socket arrangement. The barrel is connected by a bar to the recoil cylinders which in turn are attached to bipod shock absorbers.

Elevation of the piece is accomplished by turning the crank at the junction of the bipod legs and elevating screws. A knob at the end of the traversing screw, where the barrel is collared to the bipod, is turned to accomplish traverse.

The mortar is laid-in and leveled in the same manner as would be done with the U. S. 81-mm Mortar M1, and the sight also is operated in a similar fashion. To fire the piece the projectile is allowed to slide down the barrel fins-first. The firing pin fires the igniting charge. Both high-explosive and chemical shells are fired.

In the Bougainville fighting the Japanese used a much improved version of the Model 94, known as the Model 97 (1937) 90-mm mortar. It weighs 120 pounds less than the Model 94, and this lightness is a great advantage in difficult jungle terrain where such weapons ordinarily are hand-carried. This lightness has been achieved by elimination of the heavy recoil mechanism found on the older model, and the redesigned clamping collar and saddle are lighter than these parts of the Model 94. The new model has the same maximum range and other firing characteristics as the earlier version.

In China the Japanese have employed a 150-mm mortar. This weapon appears to be of conventional design, incorporating baseplate, bipod, and elevating screw. It is tentatively identified as the Model 93 (1933) and is intended for use against field fortifications and for effect on morale.

Mortars—Table of Characteristics

Model 98 (1938) 50-mm mortar

Ammunition.....	10-pound stick bomb
Total weight.....	48 pounds
Range.....	100-150 yards

Model 11 (1922) 70-mm mortar

Total weight.....	133.75 pounds
Barrel.....	Rifled bore
Range.....	3,000 yards (approx)

70-mm barrage mortar

Ammunition.....	Shell containing parachute bombs
Range.....	3,000-4,000 feet (vertical)



Model 97 (1937) 81-mm mortar

Rate of fire (estimated).....	18 to 30 rounds per minute
Weight.....	145 pounds
Range.....	3,000 yards (maximum)

Model 99 (1939) 81-mm mortar

Ammunition.....	7.2 and 14.3-pound shells
Total weight.....	52 pounds
Minimum range:	
7.2-pound shell.....	545 yards
14.3-pound shell.....	207 yards
Maximum range:	
7.2-pound shell.....	3,280 yards
14.3-pound shell.....	1,312 yards
Rate of fire.....	15 rounds per minute

Model 94 (1934) 90-mm mortar

Ammunition.....	HE and incendiary shells
Length of barrel with breech cap.....	51 $\frac{1}{4}$ inches
Weight in action.....	340 pounds
Range.....	612 to 4,155 yards

Model 93 (1933) 150-mm mortar

Ammunition.....	44 pound HE shell
Weight of assembled piece.....	557 pounds
Rate of fire.....	3 rounds per minute
Maximum range.....	2,310 yards

Antitank and Infantry Guns

The Model 97 (1937) 20-mm antitank rifle is a single-purpose, semi- or full-automatic antitank weapon. It is frequently referred to as a machine cannon, in view of its full-automatic character. Since the piece weighs only 150 pounds it can be carried by two men and maneuvered in any terrain. The

Figure 68. Model 93 (1933) 150-mm heavy mortar (opposite page).

normal method of carrying, however, utilizes carrying handles in the brackets affixed to the front and rear of the cradle and requires three or four men.

Prominent identification features of the weapon are the front hipod and rear monopod, the low silhouette, the nonadjustable inverted-V front sight, and the peep sight to the rear. The weapon is gas-operated, air-cooled, and magazine-fed.

There are two safety devices on the piece. One is a trigger block, located on the left side of the trigger housing above the pistol grip. This, when rotated, prevents the trigger from being pulled. The other device is a bolt stop on the right rear side near the top of the receiver; when it is turned, the bolt is held in its rearward position.

Elevation of the piece is done by turning the knurled collars on the legs of the bipod. A traverse up to 45 degrees is possible by moving the shoulder stock. The front bipod swivels, but the rear leg must be reset in the ground for each change of position.

The gun is cocked by pulling to the rear the retracting handle on the left side of the receiver. The bolt then is engaged and held in the rear by the stop, permitting the insertion of a vertical, box-type magazine into the top of the receiver. The bolt stop is then released and the trigger block disengaged. The retracting handle is pushed forward and, when the trigger is pulled, the piece will deliver full-automatic fire. Release of the trigger stops the fire by forcing a sear up into the receiver to hold the operating parts to the rear.

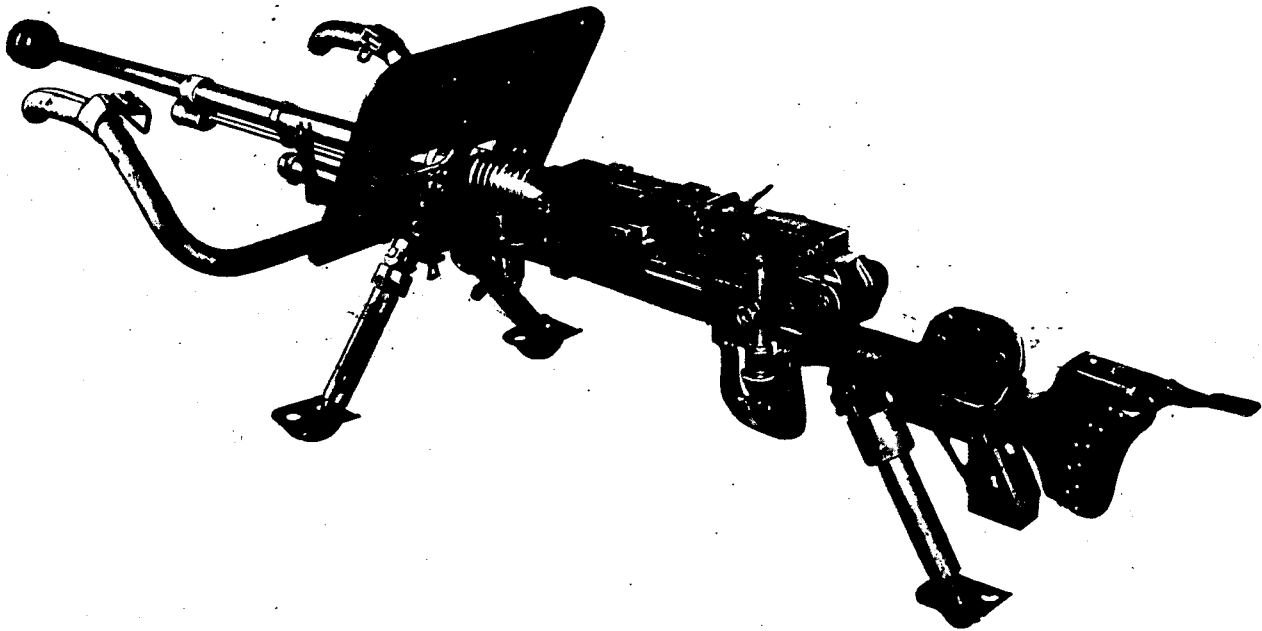

Figure 69. Model 97 (1937) 20-mm antitank rifle with shield and front carrying handles.

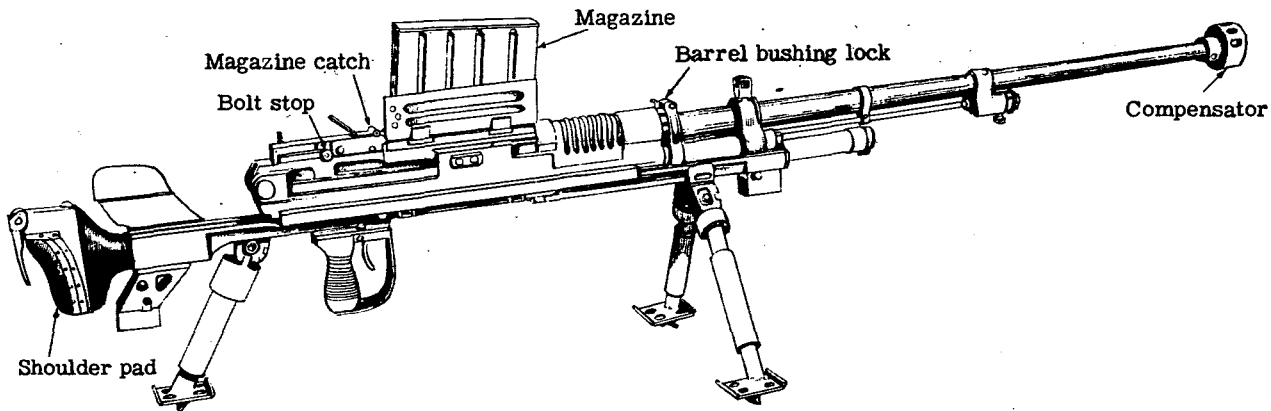
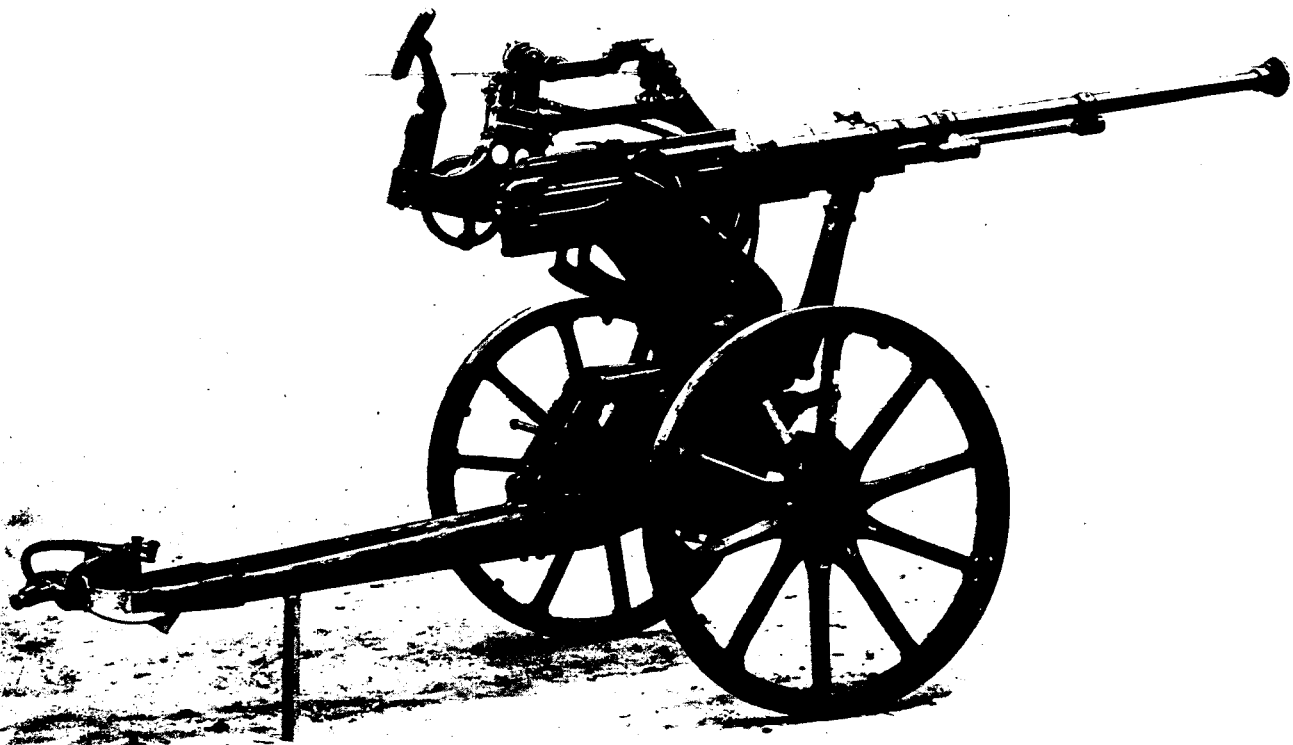

Figure 70. Model 97 (1937) 20-mm antitank rifle (right side).



Both armor-piercing shot and high-explosive shells with point-detonating fuze are fired from the Model 97. It must be emphasized that this ammunition has a smaller shell case than the 20-mm rounds made for the Model 98 (1938) AA/AT machine gun.

The Model 98 (1938) 20-mm machine cannon is an all-purpose weapon. Light in weight and very maneuverable, it can be placed in battery as an antiaircraft gun by an experienced crew in less than three minutes, making it an effective weapon for defense against low-flying aircraft. Since it has a split trail and wheels, the piece also can be used for general field-artillery purposes.

There are close similarities between the mechanism of the Model 98 and that of the Model 97 20-mm antitank rifle. However, the Model 98 may be fired either as a semi- or full-automatic weapon. It is gas-operated and magazine-fed. Two spring-loaded cylinders, one on each side of the barrel, constitute the recoil system. The vertical, box-type magazine which holds 20 rounds fits into a slot in the top of the receiver. For traveling, towing shafts are inserted in slots at the ends of the trails, and the forward part of the barrel is held to the carriage by a traveling lock.

Two safety devices are installed. A lock on the firing handle, to the left and rear of the gun, must be depressed before the handle can be moved forward. There also is a manual safety

Figure 71. Model 98 (1938) 20-mm antiaircraft-antitank machine cannon in traveling position (opposite page).

to the rear and upper right of the receiver which must be turned counterclockwise before the weapon can be fired.

After the trails and outrigger are set in the ground, the crank-shaped axle is swung so that the weapon rests on them, and the wheels are clear of the ground and can be removed. The gun is elevated by a handwheel to the left rear, and traversed by pressing on the shoulder rest.

To fire, a loaded magazine is placed into the slot on the top of the receiver. The operating handle then is pulled to the rear and pushed forward again. This operation pushes the first round into the chamber. Pressing the lock on the firing handle, and moving the handle forward, fires the piece. Either automatic or semiautomatic fire may be chosen by adjustment of the change lever at the right rear of the sleigh.

Both high-explosive and armor-piercing ammunition are used. Both have abnormally large brass shell-cases, the size of which is the feature that distinguishes the ammunition for this gun from that intended for the Model 97 20-mm antitank rifle.

The Model 11 (1922) 37-mm gun has been superseded by weapons of more modern design, but it may still be encountered in some combat areas. Four men who constitute the normal crew can carry the weapon, which in appearance is similar to the U. S. 37-mm gun M1916. It is easily identified by its very short barrel and tubular steel trails. Barrel and breech form one integral part; the breech has a vertical sliding-wedge block which is operated manually or automatically. A simple telescopic sight is standard on the weapon.

There are both elevating and traversing handwheels. A

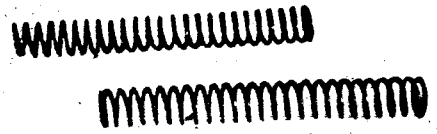
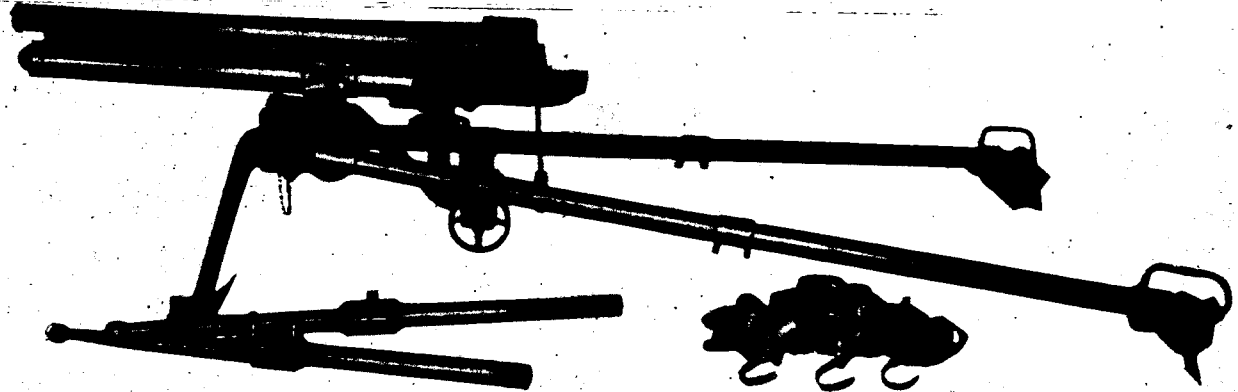
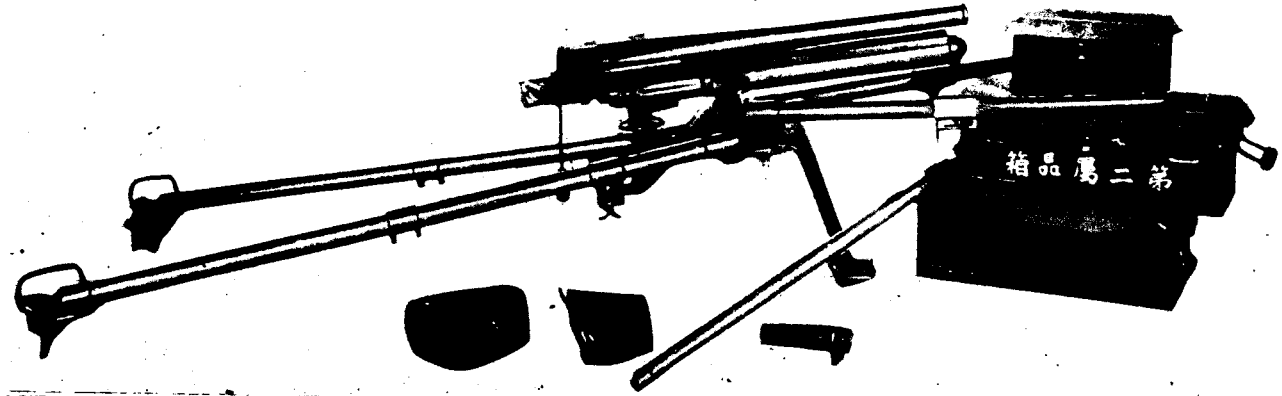

locking mechanism holds the breechblock closed and must be disengaged prior to firing. A round then is inserted in the chamber and the breech automatically closes. Adjustment can be made, however, to permit manual operation of the breechblock. A lanyard is attached to the firing mechanism.

The Model 94 (1934) 37-mm gun is an infantry close-support gun used both as an antitank and antipersonnel weapon. It has a long slender barrel, a low mount, and spade brackets on the trails. The weapon may be either manhandled or horsedrawn.

Like the Model 11, barrel and breech are integrated. The breechblock is a horizontal sliding wedge. When a round is fired, the breech opens and the cartridge case is extracted automatically. The breech remains open until another round is inserted in the chamber.

The elevating mechanisms are used to lay-in the piece. One handwheel, to the left above and forward of the breech, moves the telescope and barrel. The elevating handwheel proper moves only the barrel—this wheel is to the right and forward of the breech. Traversing is accomplished by a handwheel at the left of the breech.

Three safety devices must be disengaged to fire the piece. A safety lock on the breechblock is turned to the vertical position for firing. Secondly, the breechblock operating-handle latch is disengaged by forcing down the operating handle.

Figure 72. Two views of Model 11 (1922) 37-mm gun showing accessories (opposite page).

Finally, the safety lock to the right of the firing knob is disengaged to permit pulling the knob to the rear.

To load and fire, a round is inserted in the chamber automatically closing the breech. The firing knob then is pulled outward and to the rear. Normally, a five-man crew serves the gun—a chief of section, a gunner, a gunner's assistant, and two ammunition carriers. Armor-piercing, high-explosive, and shrapnel types of ammunition are furnished for use in the Model 94.

The Model 1 (1941) 47-mm gun is a new antitank and anti-personnel weapon of modern design. It has a long barrel with muzzle reinforcement, exceptionally long trails, and rubber-tired, perforated, steel-disc wheels. It is designed for motor transport only, with the trails closed and locked with a yoke. Its great length and low clearance make it difficult to manhandle except in exceptionally favorable terrain. The breechblock is the horizontal sliding-wedge type, and may be operated either manually or semiautomatically.

Operational details are not known but it is believed that the gun is fired in the same manner as the Model 94 37-mm gun. It fires rimmed and armor-piercing high-explosive with a brass case. The case has a comparatively large diameter and is necked down to take the 47-mm projectile.

The Model 92 (1932) 70-mm howitzer is the standard infantry-support piece of this category. It is horse-drawn but presumably could be manhandled by its ten-man section. It has a low mount, an extremely short barrel, and a sliding plate on the shield.

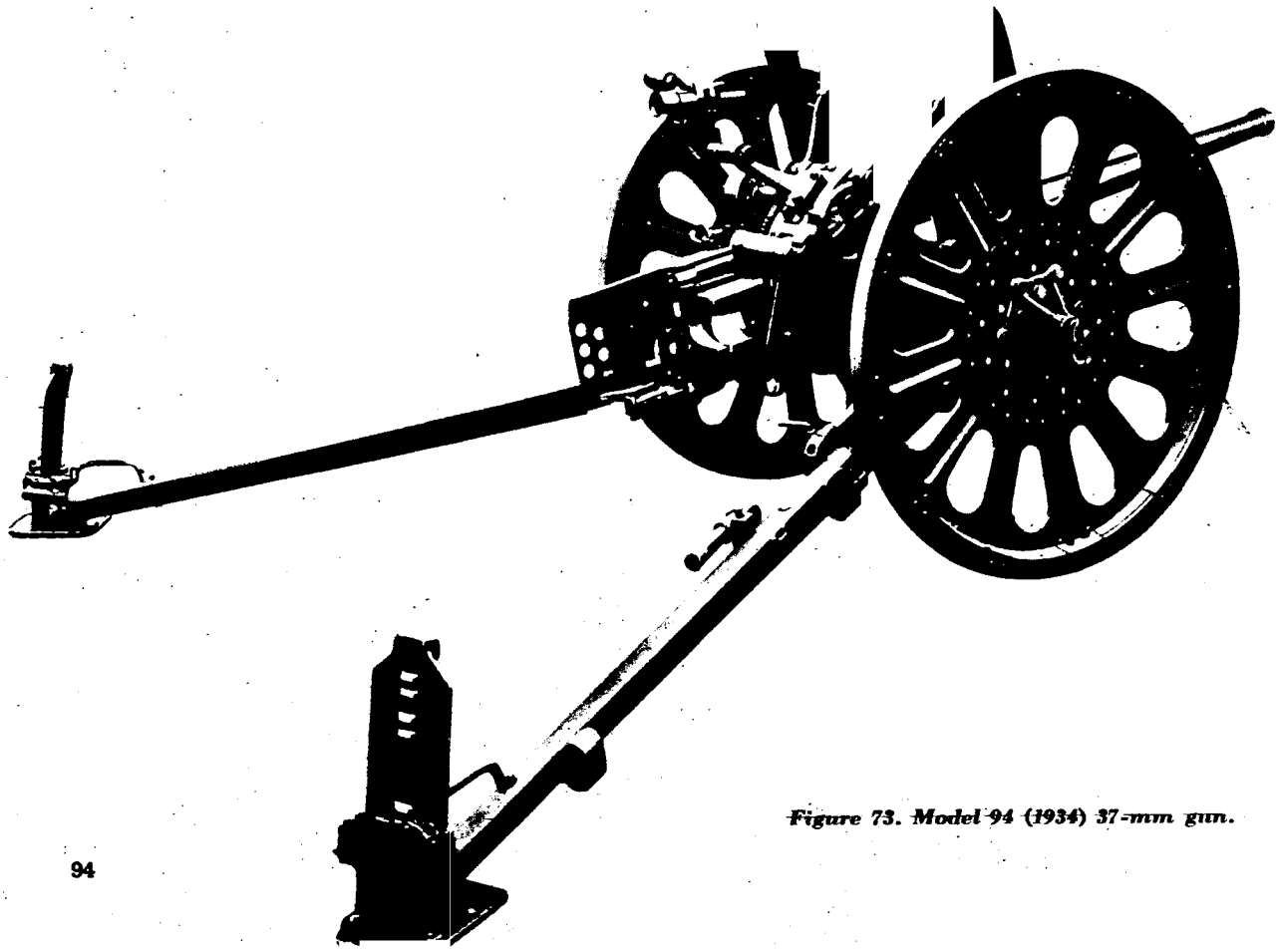

Figure 73. Model 94 (1934) 37-mm gun.

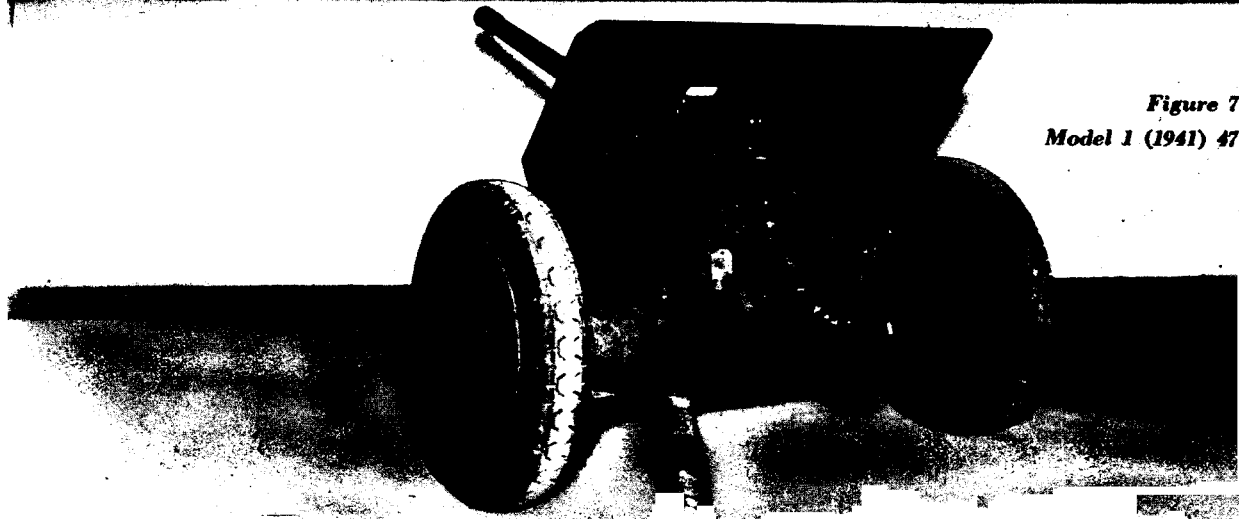
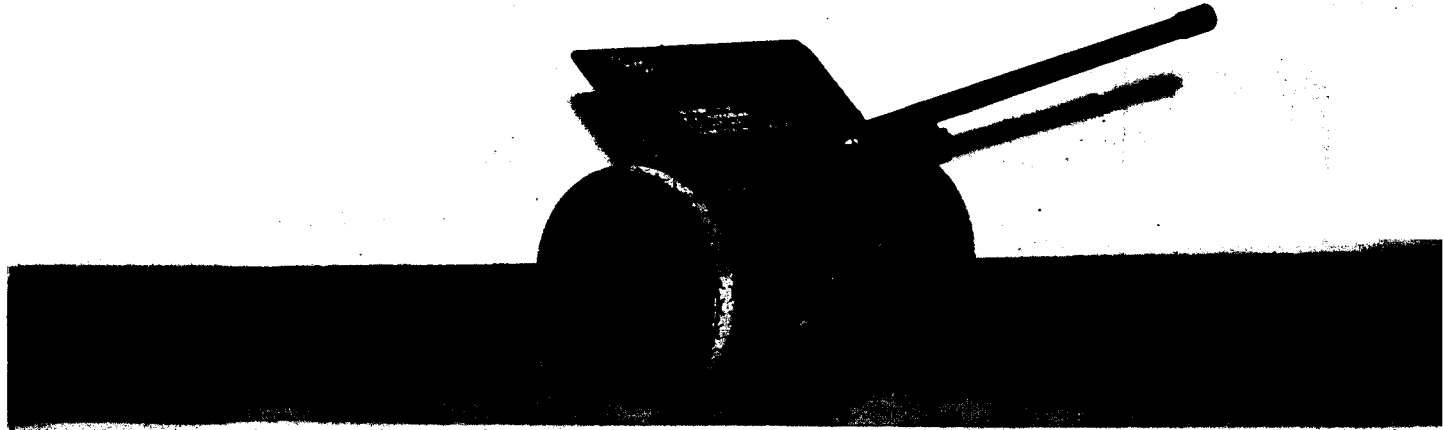
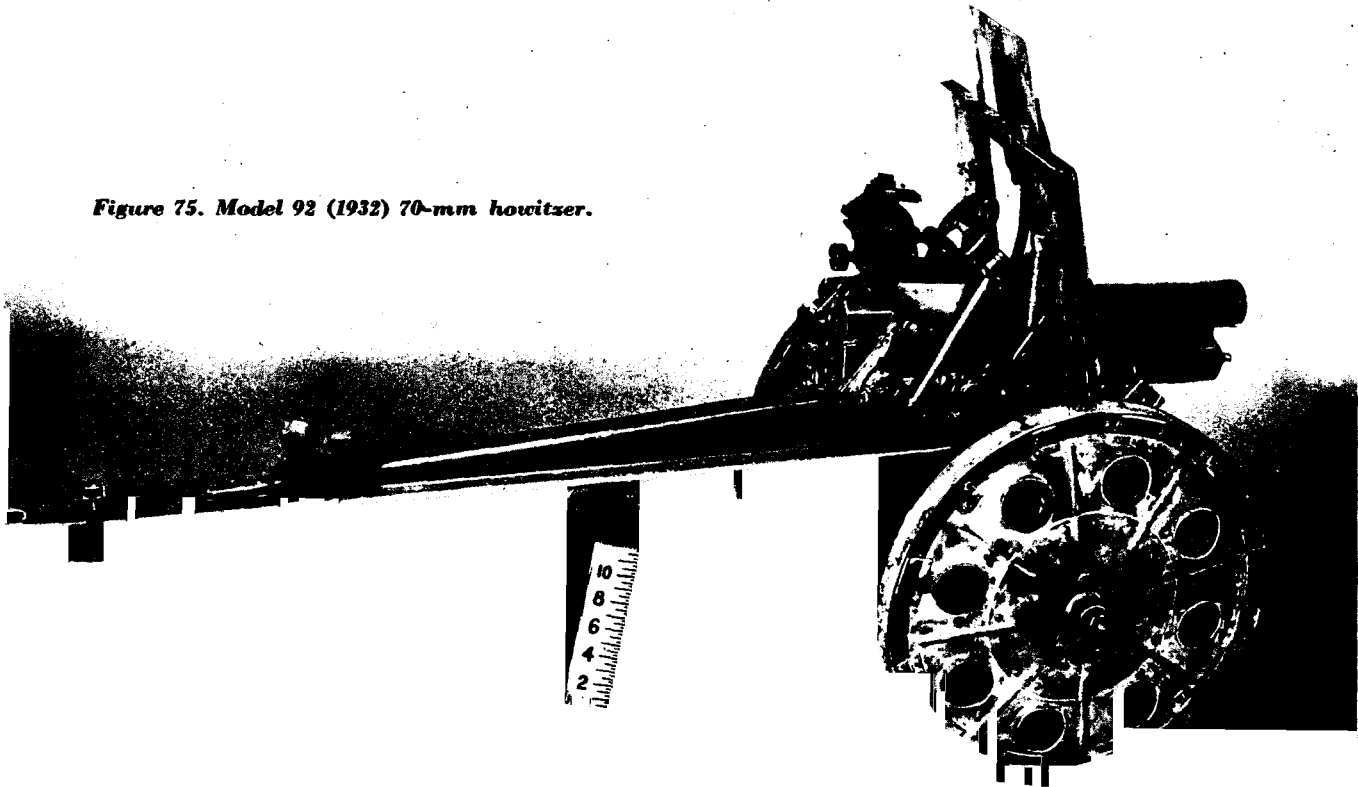

Figure 74.
Model 1 (1941) 47-mm gun.

Figure 75. Model 92 (1932) 70-mm howitzer.



Barrel, breech ring, and top sleigh are all of one forging. The breechblock is the interrupted-thread, swing-down type, and is manually operated. The trails which lock together for travel have two extensions for horse transportation. The wheels are steel disc with steel rims; however, the model also has been found equipped with wooden artillery wheels.

There are two important safety features on the weapon. The safety lock, to the right of the firing mechanism on the breech carrier, must be in the "down" position before the piece can be fired. Also the breechblock operating latch must be depressed before the breech can be operated. Note that the gun cannot be fired unless the breech is fully closed, and that this, in effect, constitutes another safety device. The Model 92 uses the same panoramic sight employed on Japanese field-artillery weapons. It is mounted on the left side of the piece and includes a range drum, an elevating bubble, and a cross-leveling bubble. The piece is elevated by a handwheel on the right of the carriage, and traversed by one on the left side.

To fire the piece it is necessary to open the breechblock manually to insert a round into the chamber. The breech is then closed, after which the safety lock is moved to the "up" position which prevents its firing while a lanyard is attached. When ready to fire, the safety lock is released and the lanyard pulled.

The gun uses semifixed ammunition with a brass or a brass-

plated steel case. High explosive and shrapnel both are used; the high-explosive shell weighs 8.36 pounds and has a burst danger area of 40 radial yards.

The Model 41 (1908) 75-mm mountain or infantry gun originally was used as a field artillery pack gun. It has been superseded to a great extent, however, by more modern weapons for this purpose, and now is issued as a regimental infantry gun. It has been encountered in virtually every U. S. Japanese combat theater.

The gun has an interrupted-thread, swing-type breechblock. The recoil mechanism is hydrospring and there are no equalizers or equilibrators. The gun is mounted on a field carriage with steel-rimmed wooden wheels. The trail is the modified box type, constructed of tubular steel. The two parallel trails are connected to a large, single demountable spade. The elevation handwheel is on the left side of the carriage, while the traversing wheel is to the right rear.

There are three safety devices. On the left of the rear plate of the breechblock is located the safety lock which must be in the "down" position to fire the piece. The breechblock has an operating-handle latch which locks the breech in a closed position after it has been fully closed, and there is a rack lock which automatically prevents the breechblock from rotating when the breech is opened and closed. The gun is fired in the same manner as the Model 92 70-mm howitzer.

Figure 76. Model 41 (1908) 75-mm mountain (infantry) gun.

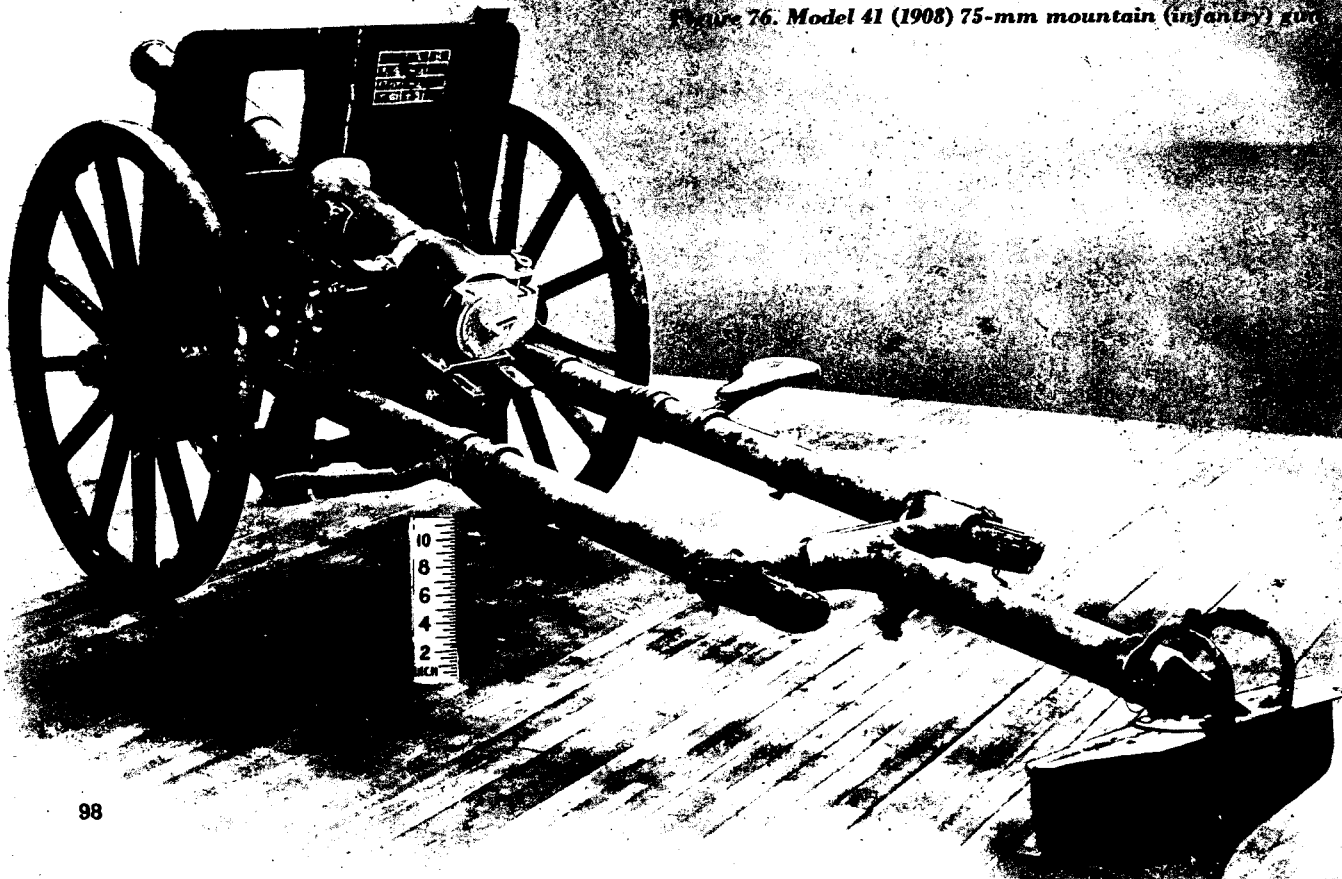

Antitank and Infantry Guns—Table of Characteristics

Model 97 (1937) 20-mm AT rifle

Principle of operation.....	Gas-operated, semi- or full-automatic
Ammunition.....	High-explosive and armor-piercing
Type of feed.....	7-round box magazine
Weight:	
In action without shield.....	120 pounds
Complete with carrying handles.....	150 pounds
Thickness of shield armor.....	$\frac{3}{16}$ inch
Effective range.....	1,100 yards
Rate of fire.....	Unknown

Model 98 (1938) 20-mm AA-AT machine cannon

Principle of operation.....	Gas-operated, semi- or full-automatic
Ammunition.....	High-explosive, tracer, and armor-piercing
Type of feed.....	20-round box magazine
Total weight without wheels.....	836 pounds
Traverse without wheels.....	6,400 mils (360 degrees)
Elevation:	
Maximum.....	1,511 mils (85.7 degrees)
Minimum.....	-178 mils (-10 degrees)
Maximum range:	
Horizontal.....	5,450 yards
Vertical.....	12,000 feet
Muzzle velocity.....	2,720 feet per second
Rate of fire.....	120 rounds per minute
Range.....	12,000 feet (vertical)

Model 11 (1922) 37-mm gun

Weight in action.....	205.72 pounds
-----------------------	---------------

Model 94 (1934) 37-mm gun

Weight in action.....	714 pounds
Thickness of shield armor.....	0.2-mm (0.787 inch)
Range:	
Effective.....	2,500 yards
Maximum.....	5,000 yards
Muzzle velocity (armor-piercing round).....	2,300 feet per second
Rate of fire.....	10 to 20 rounds per minute

Model 1 (1941) 47-mm gun

No statistics are available for this model, although firing tests have been made.

Model 92 (1932) 70-mm howitzer (battalion gun)

Total weight in action.....	468 pounds
Thickness of shield armor.....	0.156 inch
Range:	
Effective.....	1,500 yards
Maximum.....	3,000 yards
Rate of fire.....	10 rounds per minute

Model 41 (1908) 75-mm mountain infantry gun

Range:	
Effective.....	2,100 yards
Maximum.....	9,265 yards
With long-pointed shell.....	7,675 yards
With ordinary shell.....	6,575 yards
Rate of fire.....	10 rounds per minute

Figure 77. Model 38 (1905) 75-mm gun (improved).

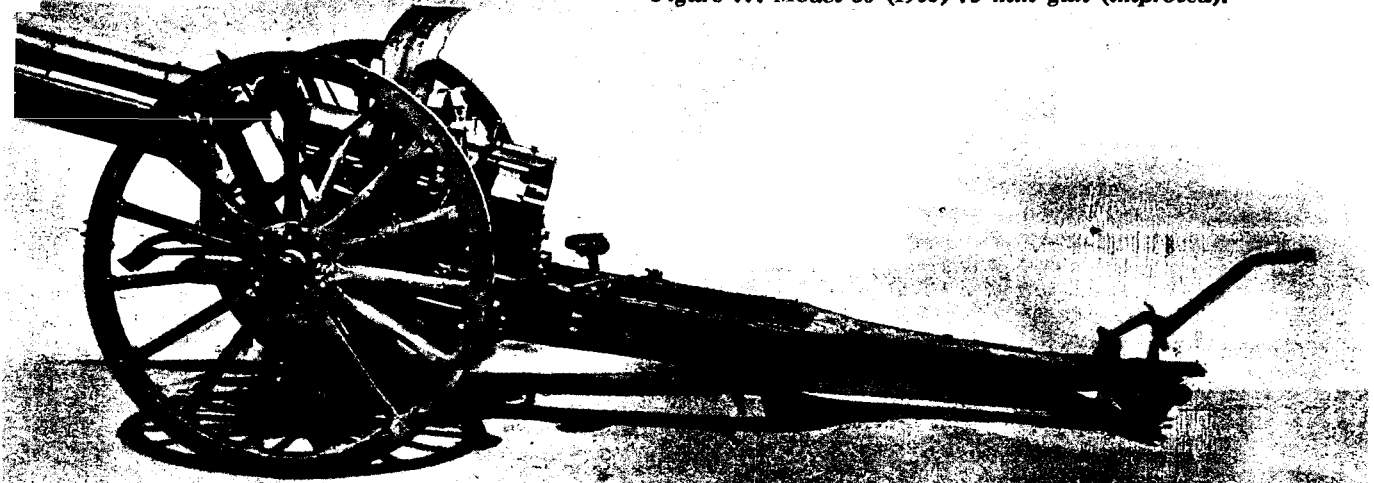

CHAPTER IV. ARTILLERY AND ARMORED MATERIEL

ARTILLERY

Japanese artillery weapons exhibit the outstanding characteristic of lightness, in some cases without the sacrifice of range, although there is reason to believe that the pieces are not as rugged as those of comparable calibers in other armies. Models introduced since 1930 have hydropneumatic recoil mechanisms of the independent type, with the liquid in direct contact with the gas. Spade-plate stabilizers, pintle traverse, and three-point suspension also are features. The horizontal sliding-wedge breechblock also is used. Equilibrators, trunnioning forward of the center of balance, and the employment of open box or split trails likewise have been typical of Japanese artillery designed or modified since the period of World War I.

Light Artillery

The Model 38 (1908) improved 75-mm gun still retains its place as the standard Japanese light division artillery piece, although it can be expected that it will be replaced gradually

by the more modern Model 90 or Model 95. The piece is a modification of the original Model 38. The plain box trail was modified into an open box which allows for an elevation of 43 degrees, although axle traverse was retained. Equilibrators were added and the piece was trunnioned to the rear. Although a hydrospring recoil mechanism still was used, it was made variable.

Although primarily a dual purpose AA/AT gun, the Model 88 (1928) 75-mm antiaircraft gun thus far has been encountered more generally in U. S. campaigns against the Japanese than any other artillery weapon. Its high muzzle velocity makes it suitable for use against ground targets, especially tanks. As an antitank weapon it has the advantages of zero elevation and an all-round traverse, but it cannot be moved quickly after firing.

The Model 90 (1930) 75-mm gun has a very long tube equipped with a muzzle brake. It has been made both for motorized or horse draft. Its muzzle-velocity, high according to Japanese standards, makes it the only Japanese weapon presently available that is suitable for effective antitank fire against heavy armored vehicles at considerable ranges. Its adaptability to this use also is increased by its wide pintle traverse.

The Model 94 (1934) 75-mm mountain gun, which has replaced the Model 41 mountain gun, has become the standard

Figure 14. Model 20 (1926) 75-mm A.S. gun



Figure 79. Model 90 (1930) 75-mm gun.

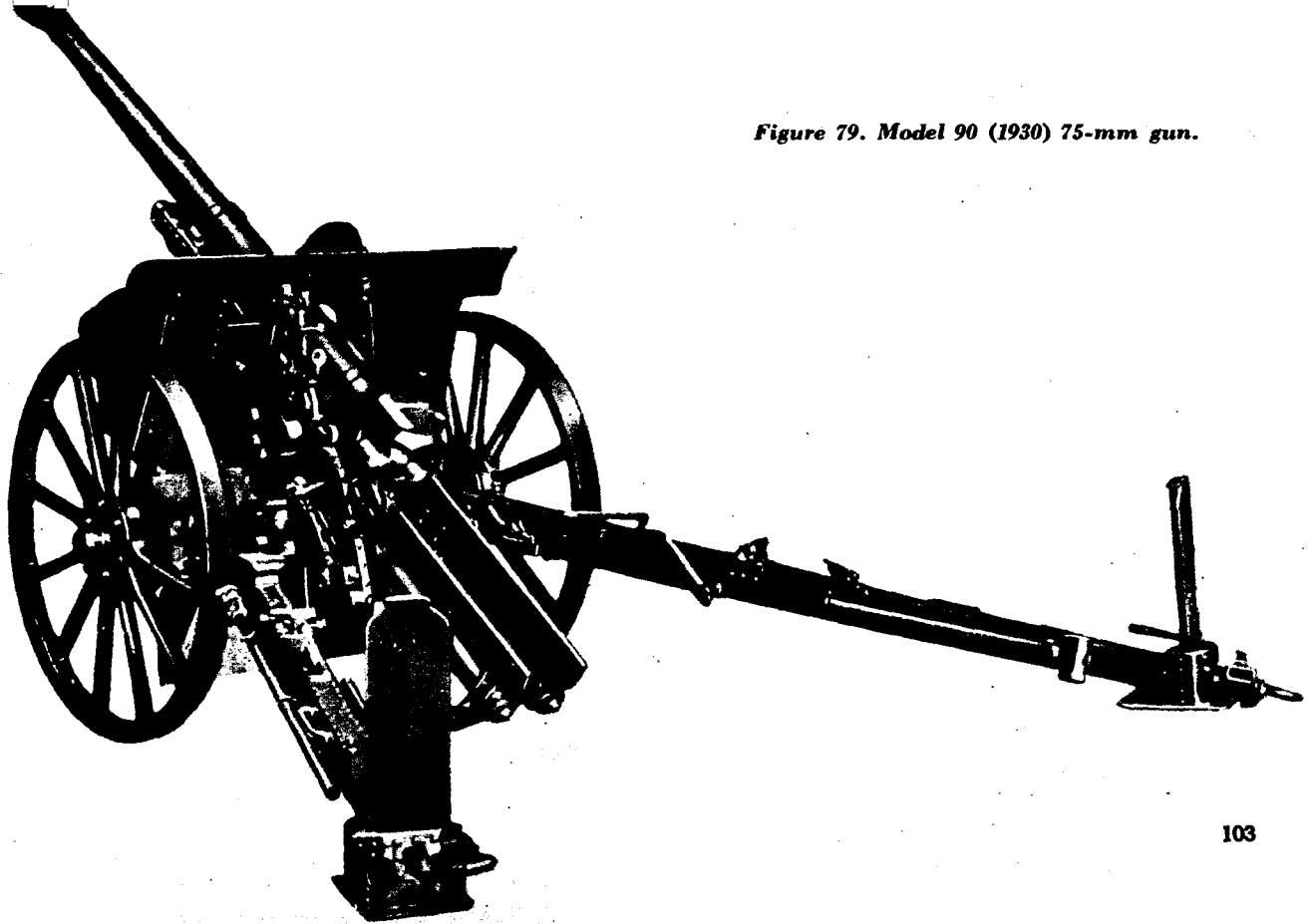
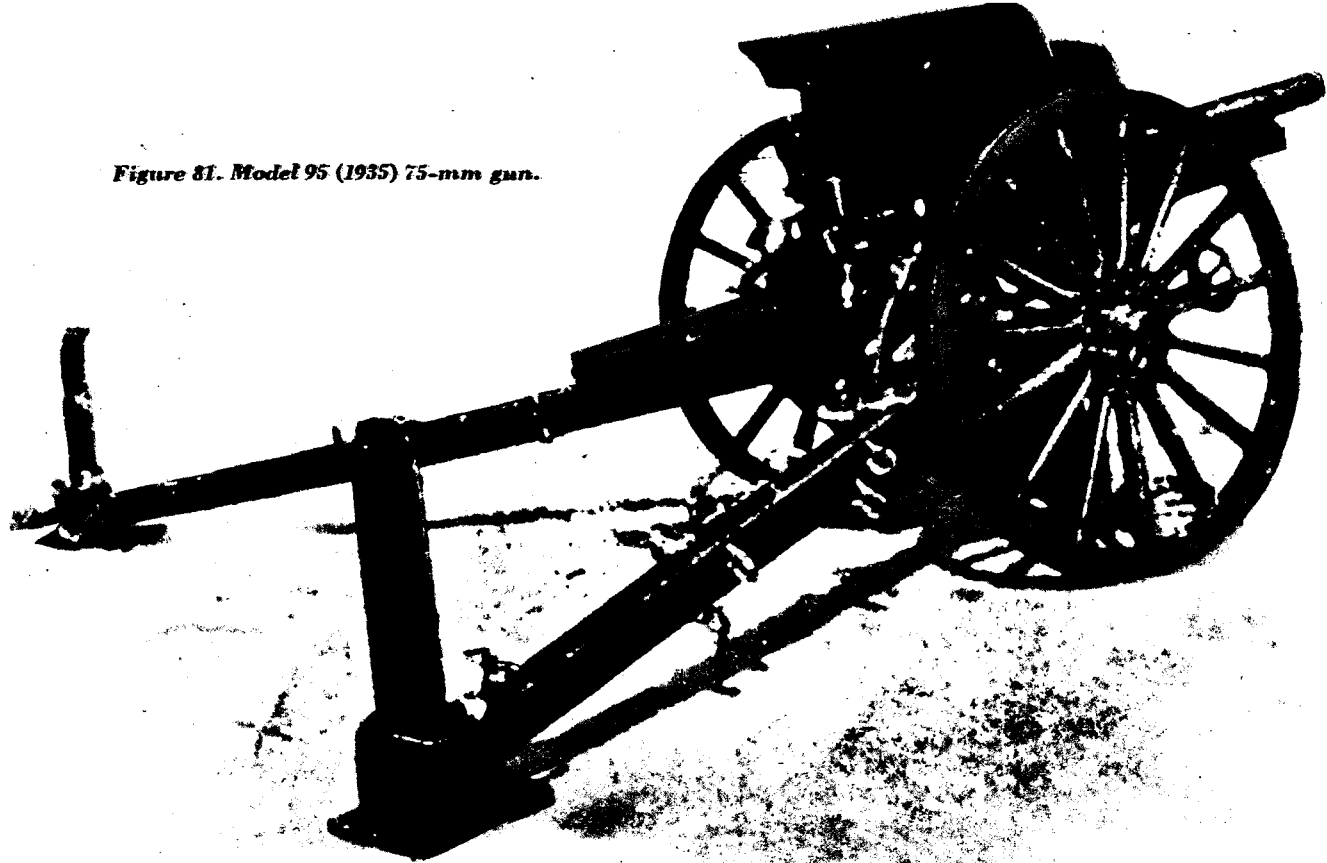

Figure 80. Model 94 (1934) 75-mm gun (mountain).



Figure 81. Model 95 (1935) 75-mm gun.



pack artillery weapon of the Japanese army. Although a light weapon, it has a number of modern construction features such as a Schneider-type hydropneumatic, independent recoil system; a horizontal sliding-wedge breechblock; split trails with spade plates; pintle traverse; and three-point suspension. Since it is trunnioned at the center of balance, it does not require equilibrators. It can be disassembled and reassembled with comparative ease. With lifting bars and ropes 18 men can carry the weapon, although in the difficult terrain where manhandling has been necessary larger groups have been assigned. It fires some of the same projectiles used in other 75-mm pieces, with the same length cartridge case used in the Model 38. However, its propellant differs by being lighter, resulting in lower chamber pressure.

The Model 95 (1935) 75-mm field gun is being encountered with increasing frequency. It may have been designed primarily to supersede the Model 41 (1908) 75-mm cavalry gun. It can fire at higher elevation than the Model 41, but it weighs 400 pounds more.

Despite its lightness, the Model 91 105-mm howitzer can throw a 35-pound shell nearly 12,000 yards. Its cradle extends almost to the muzzle end of the tube. Another prominent identification feature is the demountable spade plates. The Model 91 weighs only 3,306 pounds in firing position.

The Model 92 (1932) 105-mm gun seems almost completely to have replaced the Model 14 (1925) 105-mm gun, only 64 of which are known to have been made. The Model 92 is one of the best Japanese artillery designs, with its long barrel, short

cradle, long trails, and low silhouette. It attains great range in proportion to its unusually low weight. Although it weighs only 8,220 pounds in firing position, its maximum range is reported at approximately 20,000 yards. The weapon is equipped with spade plates and trail blocks which are demountable. Considerable difficulties apparently have been encountered with the recoil system.

Although the Model 4 (1915) 150-mm howitzer was designed during the period of World War I, it was manufactured in such quantities that it is still encountered on many fronts; but since 1936 it gradually has been replaced. Like other Japanese field artillery, it is remarkable for its long range in proportion to its weight. For travel the gun breaks into two loads. This feature has proved invaluable in terrain where bridges were flimsy or non-existent, and the road net poor. The gun's modified box trail allows it to be fired at extreme elevations, a valuable feature in jungle or rugged terrain.

A more modern Japanese 150-mm howitzer is the Model 96 (1936) which gradually is superseding the Model 4 in medium artillery units. It is heavier than the Model 4, has a longer range, and travels in a single, tractor-drawn load.

Heavy Artillery

The standard heavy artillery weapon of the Japanese army, comparable roughly with the U. S. 155-mm gun, is the Model 89 (1929) 150-mm gun. No specimen has thus far been captured. It fires a shell considerably heavier than that used in the 150-mm howitzers. It travels in two loads, but takes longer

to emplace than weapons of corresponding caliber in other armies, and is also outranged by them.

Information about other Japanese heavy artillery is inconclusive. The data in regard to pieces that have been reported have not been confirmed.

Artillery—Tables of Characteristics

Model 38 (1905) 75-mm gun (improved)

FIRING CHARACTERISTICS

Length of tube.....	7 feet 6 inches; 31 calibers
Muzzle velocity.....	Shell 1,640 f/s, HE; pointed shell 1,977.8 f/s
Maximum range.....	HE shell: 8,958 yards; pointed shell: 13,080 yards
Elevation.....	43°
Depression.....	-8°
Traverse.....	3° 30' left; 3° 30' right
Rate of fire: Normal.....	
Maximum.....	15 rpm
2 minutes.....	4 rpm
15 minutes.....	100-120 rph
Continuous.....	
Ammunition.....	HE, APHE, shrapnel, pointed, incendiary, smoke, illuminating
Type of breechblock.....	Horizontal sliding wedge

CONSTRUCTION AND MOVEMENT DATA

Weight of gun: Firing.....	2,501.5 pounds
Traveling.....	4,207.4 pounds
Method of transport.....	Horse-drawn—six horses
Practical speed on good roads.....	23.8 miles per day
Time to emplace.....	2 minutes
Wheels and tires.....	Wood-spoked artillery wheels; steel band
Trail.....	Modified box adjustable spade
Type of recoil system.....	Hydrospring automatically variable.

Model 88 (1928) 75-mm AA gun.

FIRING CHARACTERISTICS

Length of tube.....	130.5 inches; caliber 44.2
Muzzle velocity.....	2,360 f/s
Maximum range.....	29,848 feet
Elevation.....	85°
Depression.....	0°
Traverse.....	360° 5 minutes for complete traverse
Rate of fire: Normal.....	
Maximum.....	15-20 rpm
2 minutes.....	
15 minutes.....	
Continuous.....	
Ammunition.....	AA pointed shell, HE, shrapnel, smoke, incendiary, and illuminating
Type of breechblock.....	Semiautomatic horizontal sliding

CONSTRUCTION AND MOVEMENT DATA

Weight of gun: Firing.....	5,390 pounds
Traveling.....	6,039 pounds
Method of transport.....	Tractor-drawn or 6-by-6 truck with winch
Practical speed on good roads.....	Maximum: 12 mph Normal: 3 mph
Time to emplace.....	
Type of traverse.....	
Trail.....	5 out-riggers with jacks for leveling
Type of recoil system.....	Hydropneumatic, variable.

Model 90 (1930) 75-mm gun

FIRING CHARACTERISTICS

Length of tube.....	112.4 inches; 38.44 calibers
Muzzle velocity.....	2,296 f/s
Maximum range.....	16,350 yards
Elevation.....	43°
Depression.....	-8°
Traverse.....	25° right; 25° left
Rate of fire: Normal.....	
Maximum.....	15 rpm
2 minutes.....	4 rpm
15 minutes.....	100-120 rph
Continuous.....	
Ammunition.....	HE, APHE, shrapnel, incendiary, smoke, pointed.

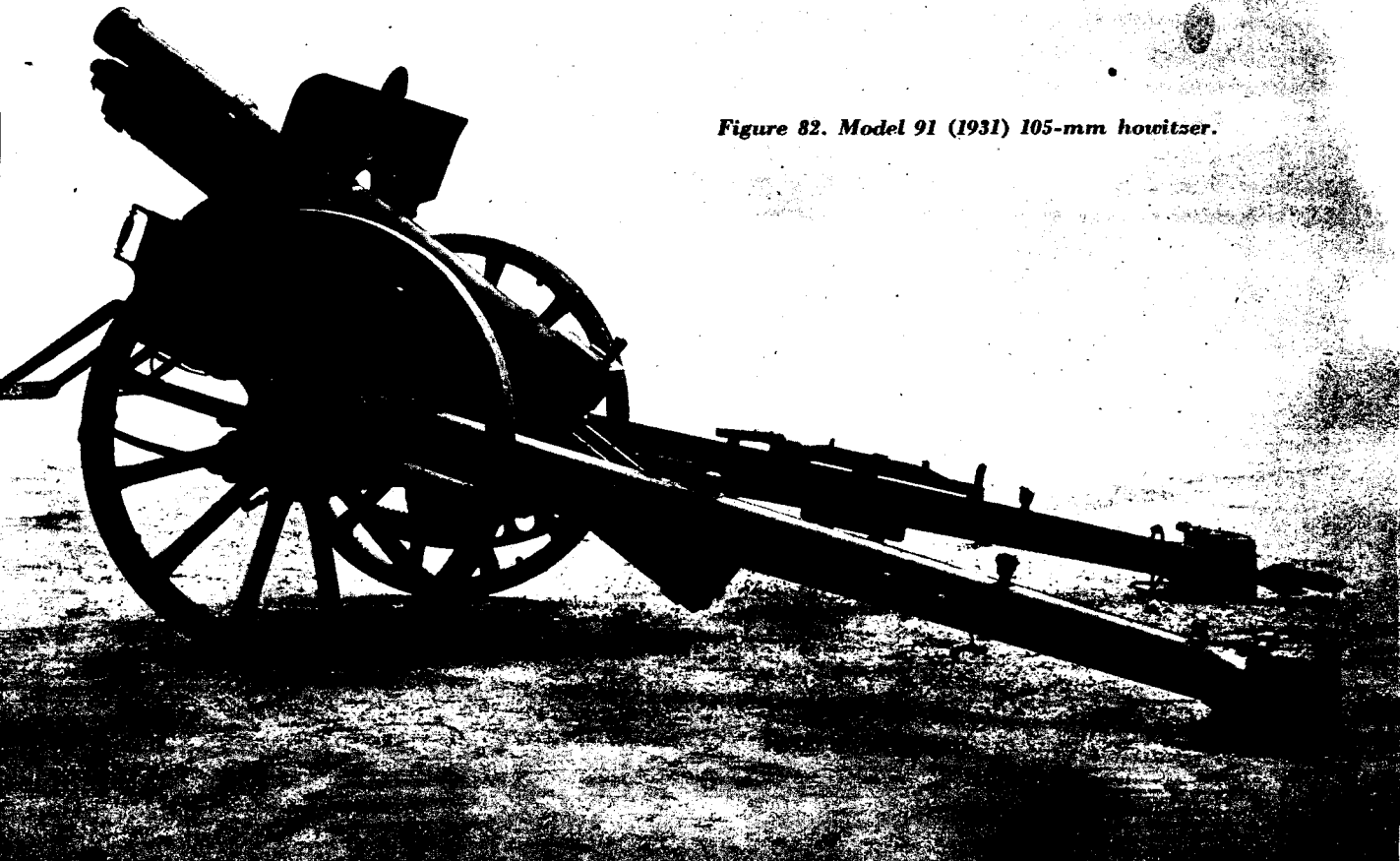

Figure 82. Model 91 (1931) 105-mm howitzer.

CONSTRUCTION AND MOVEMENT DATA

Weight of gun: Firing.....	3,085.6 pounds
Traveling.....	4,408 pounds.
Method of transport.....	4-ton tractor-drawn or horse-drawn— six horses
Practical speed on good roads.....	Maximum: 24.8 miles per hour Average: 9.3 miles per hour, 124 miles per day
Time to emplace.....	2 minutes
Wheels and tires.....	Steel band on artillery wheels and pneumatic tires on disk wheels
Trail.....	Split with demountable spade plates and fixed trail blocks
Type of recoil system.....	Hydropneumatic, constant

Model 94 (1934) 75-mm mountain gun**FIRING CHARACTERISTICS**

Length of tube.....	61.5 inches; caliber 20.8
Muzzle velocity.....	Pointed shell: 1,285.8 f/s Shrapnel shell: 1,165.4 f/s
Maximum range.....	Pointed shell: 8,938 yards (9,400) HE shell: 7,957 yards
Elevation.....	45°
Depression.....	-10°
Traverse.....	20° right; 20° left
Rate of fire: Normal.....	
Maximum.....	
2 minutes.....	15 rpm
15 minutes.....	4 rpm
Continuous.....	100-120 rph
Ammunition.....	HE, APHE, shrapnel, incendiary, illu- minating and pointed
Type of breechblock.....	Horizontal sliding
Type of firing mechanism.....	Continuous pull percussion (Krupp type)

CONSTRUCTION AND MOVEMENT DATA

Weight of gun: Firing.....	1,181.3 pounds
Traveling.....	1,091 pounds (horse or motor draft)
Weight of assemblies:	
Tube.....	206 pounds
Cradle.....	207 pounds
Left trail.....	138 pounds
Right trail.....	131 pounds
Wheels.....	152 pounds

Right bracket.....	10 pounds
Breech.....	82 pounds
Road clearance.....	10.14 inches
Method of transport.....	Horse-drawn, motor-drawn, 6 horses pack. This can also be manhandled easily by 3 men.
Practical speed on good roads.....	Pack: 12.4-15.5 miles per day; 1-2 horse draft: 21.8-31 miles per day; man pack: 327-1,090 yards per hour
Time to emplace.....	Approximately 5 minutes to unpack and assemble. 2 minutes when horse drawn
Wheels and tires.....	Steel-hand tires on spoked wheels
Trail.....	Split with demountable spade plates, and fixed trail blocks.
Type of recoil system.....	Hydropneumatic, constant, independ- ent.

Model 95 (1935) 75-mm field gun**FIRING CHARACTERISTICS**

Length of tube.....	89.7 inches; caliber 30.67
Muzzle velocity.....	1,640 f/s
Maximum range.....	Pointed (?) 11,990 yards HE (?) shell 9,810 yards
Elevation.....	43°
Depression.....	-8°
Traverse.....	25° right; 25° left
Rate of fire: Normal.....	
Maximum.....	10-12 rpm
2 minutes.....	
15 minutes.....	
Continuous.....	
Ammunition.....	HE, APHE, shrapnel, smoke, incendi- ary, illuminating, and pointed.
Type of breechblock.....	Horizontal sliding

CONSTRUCTION AND MOVEMENT DATA

Weight of gun: Firing.....	2,437.6 pounds
Traveling.....	4,252.6 pounds
Method of transport.....	Horse drawn—six horses
Practical speed on good roads.....	31.1 miles per day
Time to emplace.....	
Wheels and tires.....	
Trail.....	Split, demountable spade plates fixed trail blocks
Type of recoil system.....	Hydropneumatic, constant

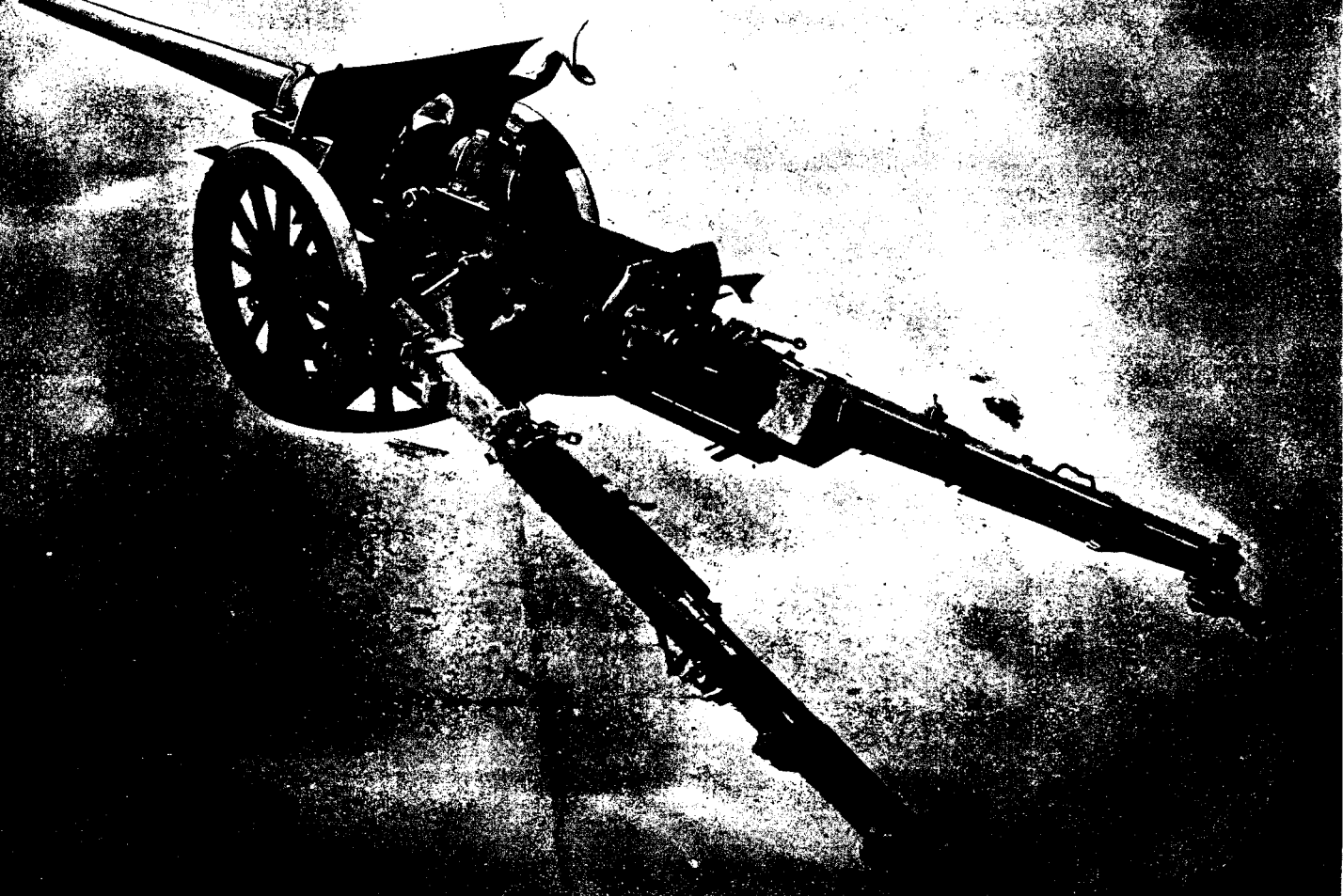

Model 91 (1931) 105-mm howitzer

FIRING CHARACTERISTICS

Length of tube.....	8 feet 4 inches; 24 calibers
Muzzle velocity.....	1,790 f/s
Maximum range.....	Charge 1: 11,772 yards Charge 2: 8,502 yards Charge 3: 6,322 yards Charge 4: 5,123 yards
Elevation.....	45°
Depression.....	-5°
Traverse.....	20° right; 20° left
Rate of fire: Normal.....	
Maximum.....	6-8 rpm
2 minutes.....	
15 minutes.....	2 rpm
Continuous.....	50-60 rph
Ammunition.....	HE, APHE, pointed, shrapnel, and incendiary
Type of breechblock.....	Interrupted screw

CONSTRUCTION AND MOVEMENT DATA

Weight of gun: Firing.....	3,306 pounds
Traveling.....	4,363.9 pounds
Method of transport.....	Horse drawn—six horses
Practical speed on good roads.....	24.8 miles per day
Time to emplace.....	3 minutes
Wheels and tires.....	Steel tires on artillery wheels
Trail.....	Split trail, demountable spade plates, trail blocks integral to trails.
Type of recoil system.....	Hydropneumatic

Model 92 (1932) 105-mm gun

FIRING CHARACTERISTICS

Length of tube.....	184.3 inches; 45 calibers
Muzzle velocity.....	2,492.8 f/s
Maximum range.....	Pointed shell: 20,000 yards HE shell: 14,800 yards
Elevation.....	45°
Depression.....	-5°
Traverse.....	18° right; 18° left
Rate of fire: Normal.....	
Maximum.....	6-8 rpm
2 minutes.....	
15 minutes.....	6-8 rpm
Continuous.....	

15 minutes.....	2 rpm
Continuous.....	50-60 rph
Ammunition.....	HE, APHE, pointed, incendiary, and shrapnel. Separate loading cartridge case obturation.
Type of breechblock.....	Stage interrupted screw

CONSTRUCTION AND MOVEMENT DATA

Weight of gun: Firing.....	8,220.9 pounds
Traveling.....	9,620.5 pounds
Method of transport.....	5-ton tractor drawn
Practical speed on good roads.....	8.7 miles per hour 49.7-62.1 miles per day
Time to emplace.....	5 minutes
Wheels and tires.....	Solid rubber tires on wooden wheels
Trail.....	Split 3 demountable spade plates and demountable trail blocks on each trail; wheel chocks carried in traveling in metal pockets inside trails.
Type of recoil system.....	Hydropneumatic, constant

Model 4 (1915) 150-mm howitzer

FIRING CHARACTERISTICS

Caliber.....	149.1-mm
Length of tube.....	85.4 inches; 14.6 calibers
Muzzle velocity.....	1,344.8 f/s
Maximum range.....	10,464 yards
Elevation.....	65°
Depression.....	-5°
Traverse.....	3° right; 3° left
Rate of fire: Normal.....	
Maximum.....	3-4 rpm
2 minutes.....	
15 minutes.....	1 rpm
Continuous.....	30-40 rph
Ammunition.....	HE, pointed, shrapnel, APHE, smoke, incendiary, and illuminating
Type of breechblock.....	Vertical, sliding, separate loading ammunition with cartridge case obturation.

CONSTRUCTION AND MOVEMENT DATA

Weight of gun: Firing.....	6,160 pounds
Traveling.....	
Barrel.....	4,838 pounds
Cradle.....	4,729.78 pounds

Figure 84. Model 14 (1925) 105-mm gun.

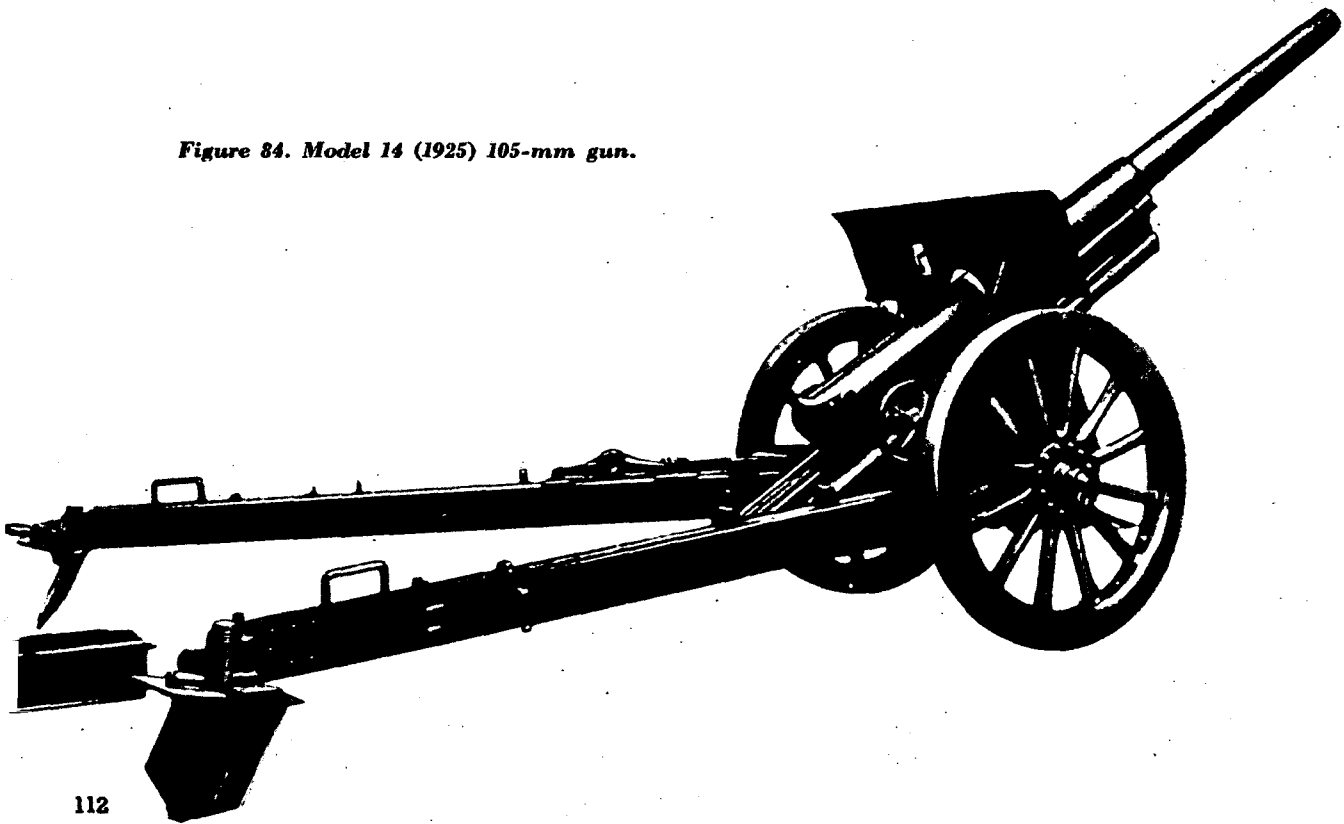

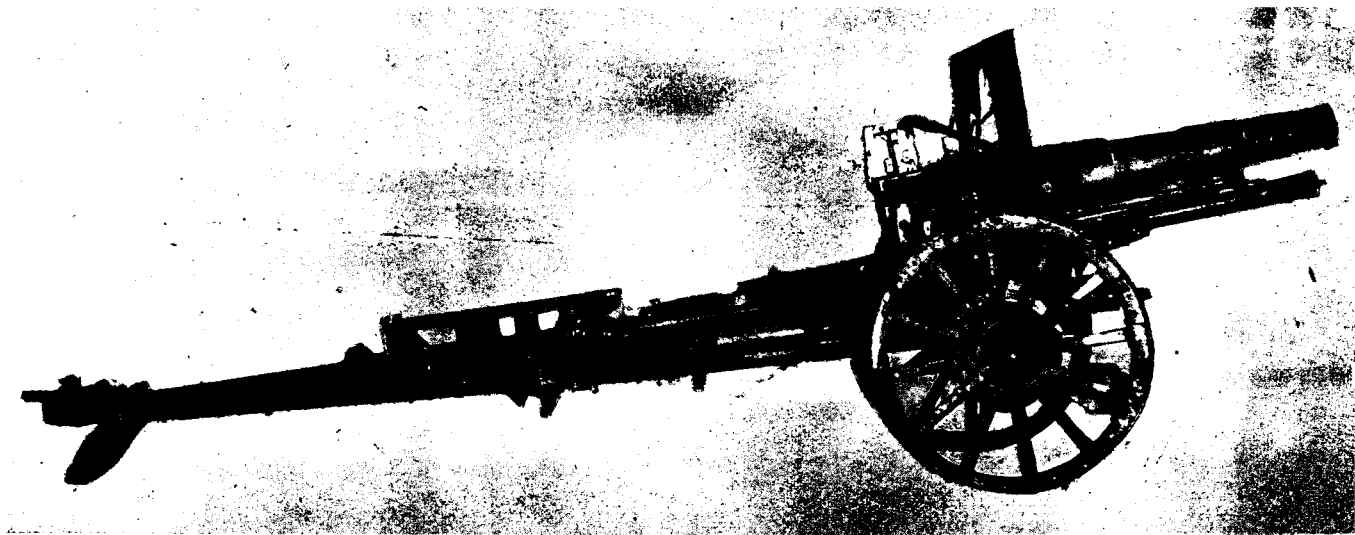
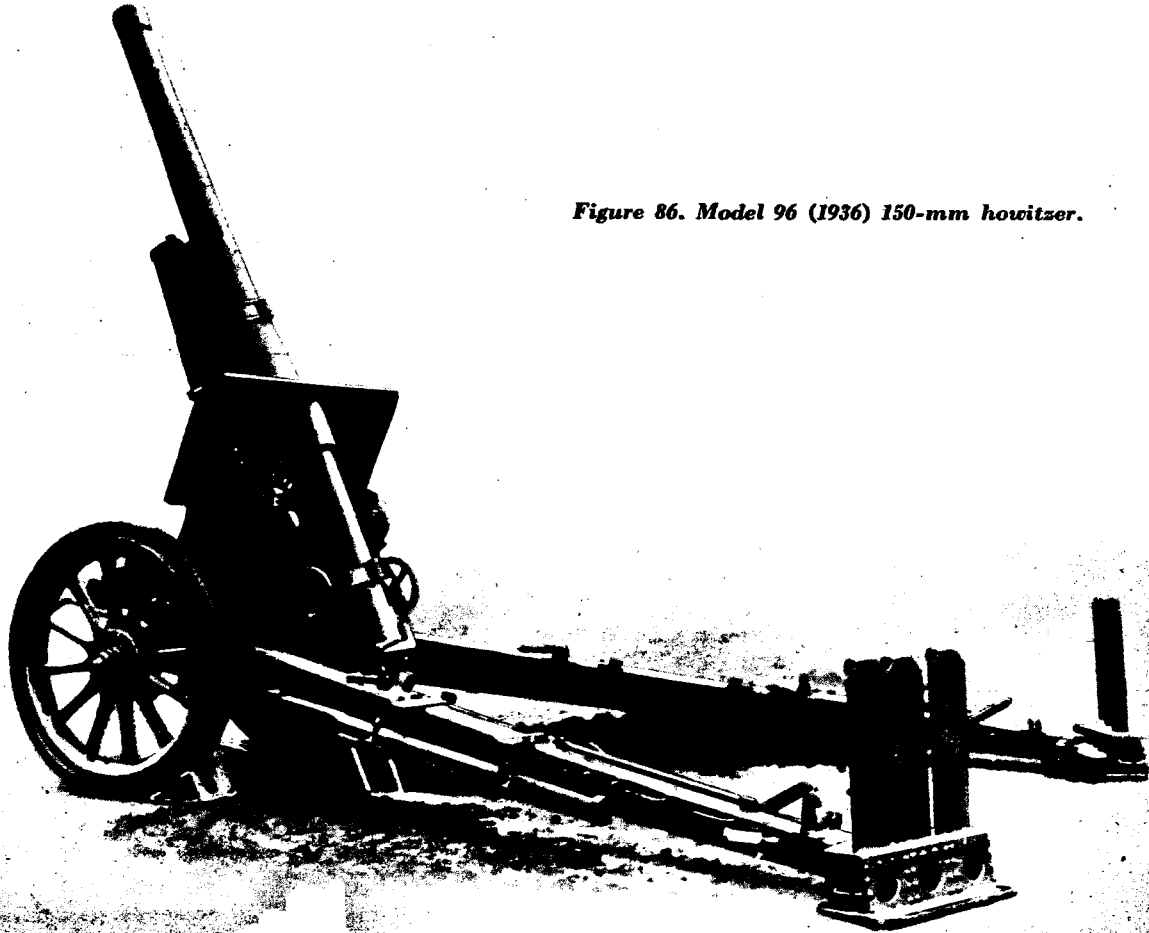

Figure 85. Model 4 (1915) 150-mm howitzer.

Figure 86. Model 96 (1936) 150-mm howitzer.



Method of transport.....	Can be transported for short distances in single load. Horse drawn, 2 loads, 6 horses each load.
Practical speed on good roads.....	40 miles per day, except on bad terrain
Time to emplace.....	10 minutes
Wheels and tires.....	Iron tires on wooden wheels
Trail.....	Modified box
Type of recoil system.....	Hydropneumatic, dependent

Model 96 (1936) 150-mm howitzer

FIRING CHARACTERISTICS

Caliber.....	149.1-mm
Length of tube.....	11 feet 6 inches; 23.37 calibers
Muzzle velocity.....	
Maximum range.....	Pointed shell: 12,971 yards HE shell: 11,336 yards
Elevation.....	65°
Depression.....	-5°
Traverse.....	15° right; 15° left
Rate of fire: Normal.....	
Maximum.....	3-4 rpm
2 minutes.....	
15 minutes.....	1 rpm
Continuous.....	30-40 rph
Ammunition.....	HE, APHE, shrapnel, pointed, smoke, and incendiary.
Type of breechblock.....	Step interrupted screw

CONSTRUCTION AND MOVEMENT DATA

Weight of gun: Firing.....	9,108 pounds
Traveling.....	10,846 pounds
Method of transport.....	5-ton tractor
Practical speed on good roads.....	19.9 mph (maximum) 8.7 mph (average) 49.7-62.1 miles per day
Time to emplace.....	7 minutes

Wheels and tires.....	Solid rubber tires, wooden artillery wheels
Trail.....	Split with 3 apade plates and a trail block for each trail. Plates and blocks demountable
Type of recoil system.....	Hydropneumatic, constant independent.

Model 89 (1929) 150-mm gun

FIRING CHARACTERISTICS

Caliber.....	149.1-mm
Length of tube.....	2,250 feet
Muzzle velocity.....	2,250 f/s
Maximum range.....	21,800 yards
Elevation.....	43°
Depression.....	-5°
Traverse.....	20° right; 20° left
Rate of fire: Normal.....	
Maximum.....	2 rpm
2 minutes.....	
15 minutes.....	
Continuous.....	

Ammunition.....	APHE, HE, shrapnel, pointed, illuminating.
Type of breechblock.....	Stage, interrupted.

CONSTRUCTION AND MOVEMENT DATA

Weight of gun: Firing.....	
Traveling.....	22,928.4 pounds
Barrel.....	17,215 pounds
Cradle.....	16,645.2 pounds
Method of transport.....	8-ton tractor drawn—2 loads
Practical speed on good roads.....	
Time to emplace.....	2 hours
Wheels and tires.....	Metallic disk wheels with solid rubber tires
Trail.....	Split
Type of recoil system.....	Hydropneumatic, variable

ARMORED MATERIEL

Japanese tank equipment has in general been inferior to equipment used by the Western Powers in the present war. Limitations on national heavy-industrial resources have compelled the Japanese to freeze tank designs from time to time in order to attain the requisite numbers of vehicles. Replacement of designs that have proved inadequate in combat has been slow, and obsolete vehicles doubtless will continue to be utilized in the various combat theaters side by side with more modern versions and new designs.

The Japanese use tankettes, light tanks, and medium tanks. Tankettes weigh less than $5\frac{1}{2}$ tons. Light tanks weigh from $5\frac{1}{2}$ to 11 tons; medium tanks, between 11 and 22 tons. Little is known about Japanese heavy tanks although some have been reported. They exist in limited numbers only and seem to be clumsy, inadequately armored, and generally poor in performance.

Light and medium tanks mount 37- or 57-mm guns, and a medium model is reported that mounts a 47-mm weapon. Machine guns are mounted in the rear as well as in the turret or front hull of most

models; it is doubtful if the rear machine gun can be fought at the same time as the other weapons. Although Japanese tank armor is of good quality, it is too thin, and inadequate attention has been paid to the potentialities of adroit use of deflection angles. Tankettes and light tanks usually have gasoline engines, but there is increasing use of Diesel engines both in medium and light vehicles.

Suspension by means of bell-crank arms, carrying rocking pairs of wheels, is widely used in conjunction with horizontal suspension springs protected by armored casings. Apparently no thought has been given to the provision of escape doors or hatches. Visibility is not as good as could be expected in modern armored vehicles. Radio is sparingly installed, apparently on the basis of one set per platoon.

It can be expected, however, that many deficiencies will be corrected in later models. The new amphibious tank, in its turret design among other features, shows evidence of intention to correct weaknesses demonstrated in combat. Mounting of 75-mm guns likewise can be anticipated in the immediate future, as well as coaxially mounted machine guns.



Figure 87. Model 92 (1932) tankette.

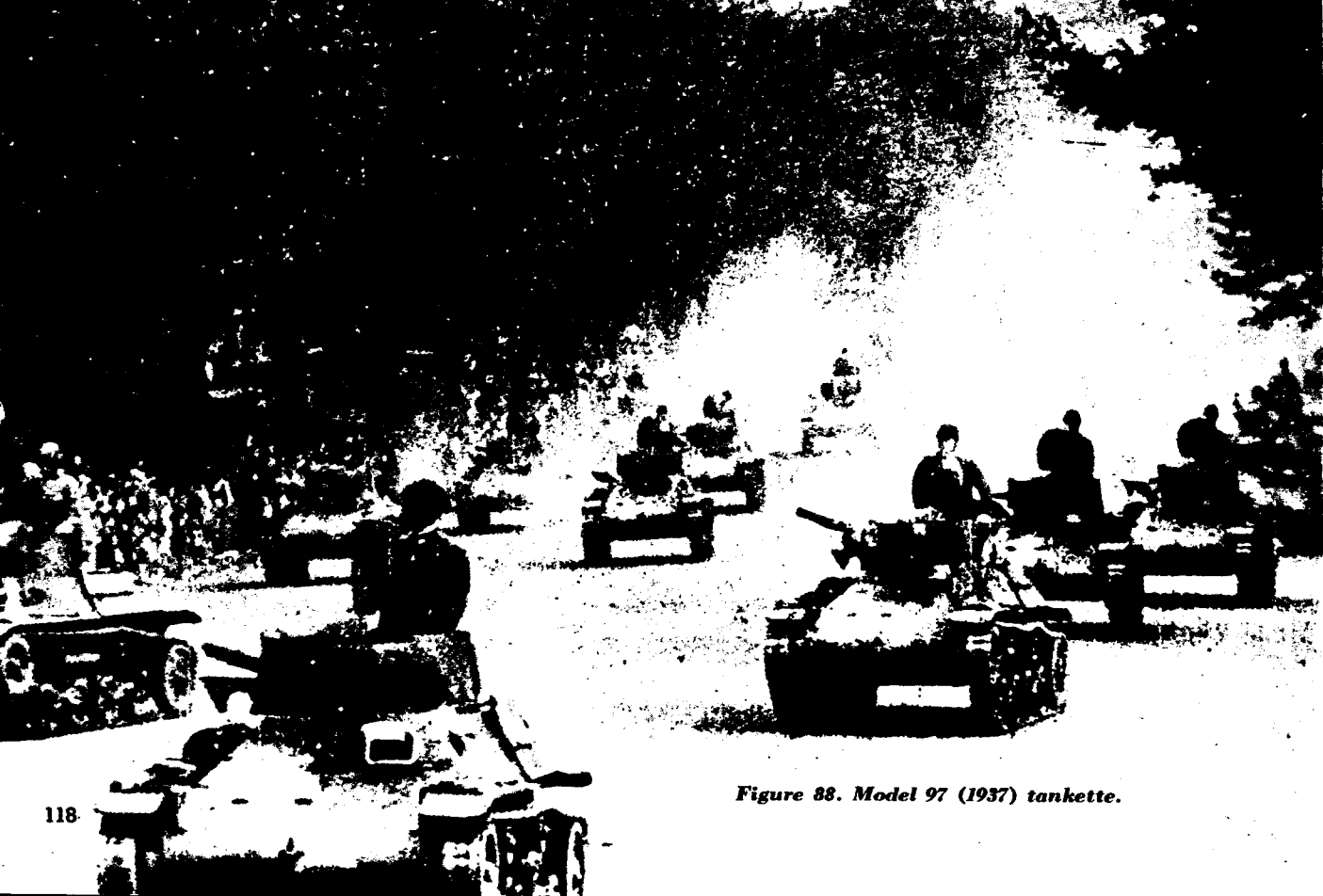

Figure 88. Model 97 (1937) tankette.

Tankettes

Tankettes have been developed progressively ever since the beginning of the Japanese war with China. They are widely employed for reconnaissance and cavalry roles. They are often utilized to tow tractor-trailers. Of combination weld and rivet construction, they have four rubber-tired bogie wheels and two return rollers on each side. Drive is by front sprocket.

The Model 92 (1932) is powered by a Diesel engine located in the left rear. Its top speed is 25 miles per hour. It is armed with a 7.7-mm machine gun. In the Model 94 (1934) the rear idler has been replaced by a trailing idler and the drive sprocket accordingly has been lowered. Power is supplied by a Ford four-cylinder tractor engine. Suspension in the Model 97 (1937) remains unchanged from the design of the 92 and 94. The hull was redesigned, however, to provide more room, and the turret was modified to permit mounting of a 37-mm anti-tank gun. Deflection angles likewise show considerable improvement over the earlier tankette types.

Light Tanks

The Model 93 (1933) light tank has a box-type hull divided into three compartments. It is powered by a six-cylinder gasoline engine in the rear of the hull. Suspension is provided by six rubber-tired bogie wheels with three return rollers on each side. Drive is by front sprocket. There is one machine gun in front and perhaps one in the rear.

Chief difference between this version and the Model 93 (improved) is the latter's use of four bogie wheels coupled in

pairs. Then, too, there is a 37-mm antitank gun in the forward part of the hull in addition to the machine gun in the turret. The gasoline engine is six-cylinder, 85-horsepower, air-cooled.

The Model 95 (1935) light tank has been in production from 1935-1942, probably representing a Japanese "freezing" of light-tank production to attain sizeable quantity of a model found reasonably satisfactory. Suspension is of the bell-crank type with armored compression springs. The hull is built over an iron frame and is provided with asbestos insulation. The model is armed with one 37-mm antitank gun and two 7.7-mm machine guns. Since the armor is comparatively thin, the Model 95 is vulnerable to 75- or 105-mm HE shell. The Keni model represents modifications of the Model 95; the motor has a horsepower rating of 140, and the tank is capable of a speed of 37 miles per hour. It is armed with a 47-mm gun and weighs 7.7 tons.

Medium Tanks

The earliest model medium tank in common use is the Model 89A (1929). It has a box-type hull. Suspension is by nine small bogie wheels and five rollers on each side. The leading bogie wheels on each side are independently suspended and there is a protective skirting over the entire suspension. Drive is by a rear sprocket and power is supplied by a gasoline motor. The tank mounts one 57-mm gun and a rear machine gun. The Model 89B differs from the Model A in that it has a longer front, a newer type cupola, and a Diesel engine.

The Model 94 (1934) was extensively used in China. It has



Figure 89. Model 93 (1933) light tank.

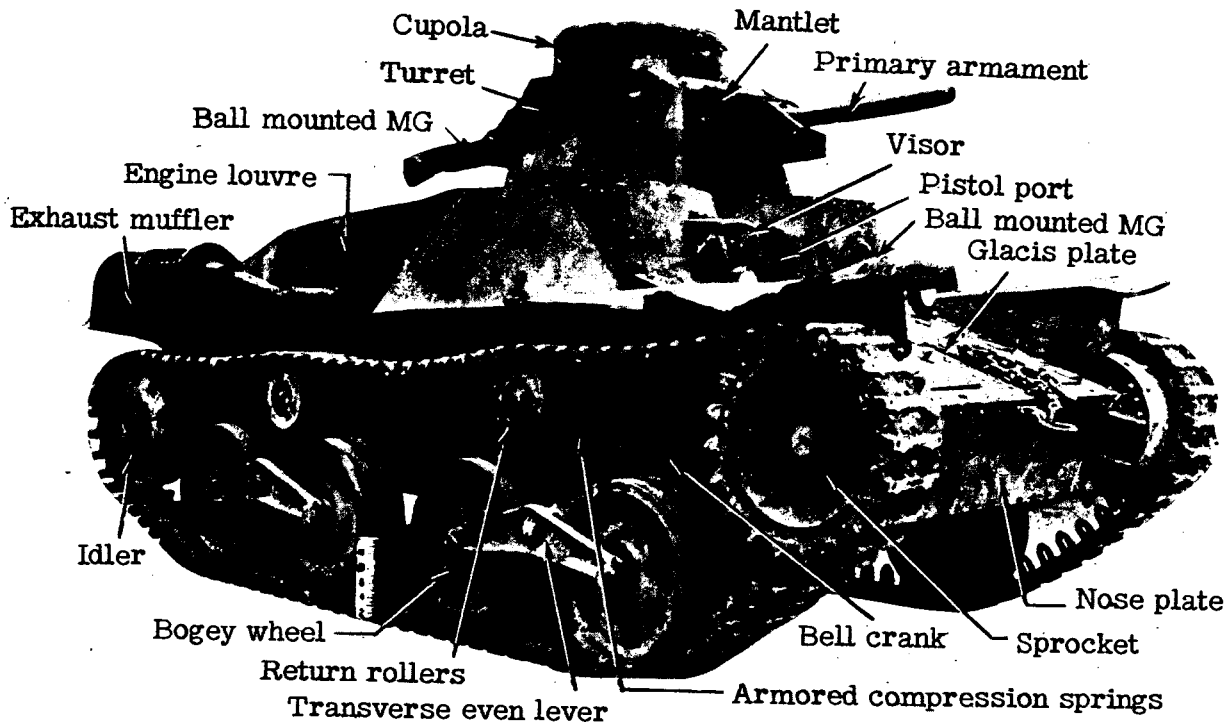
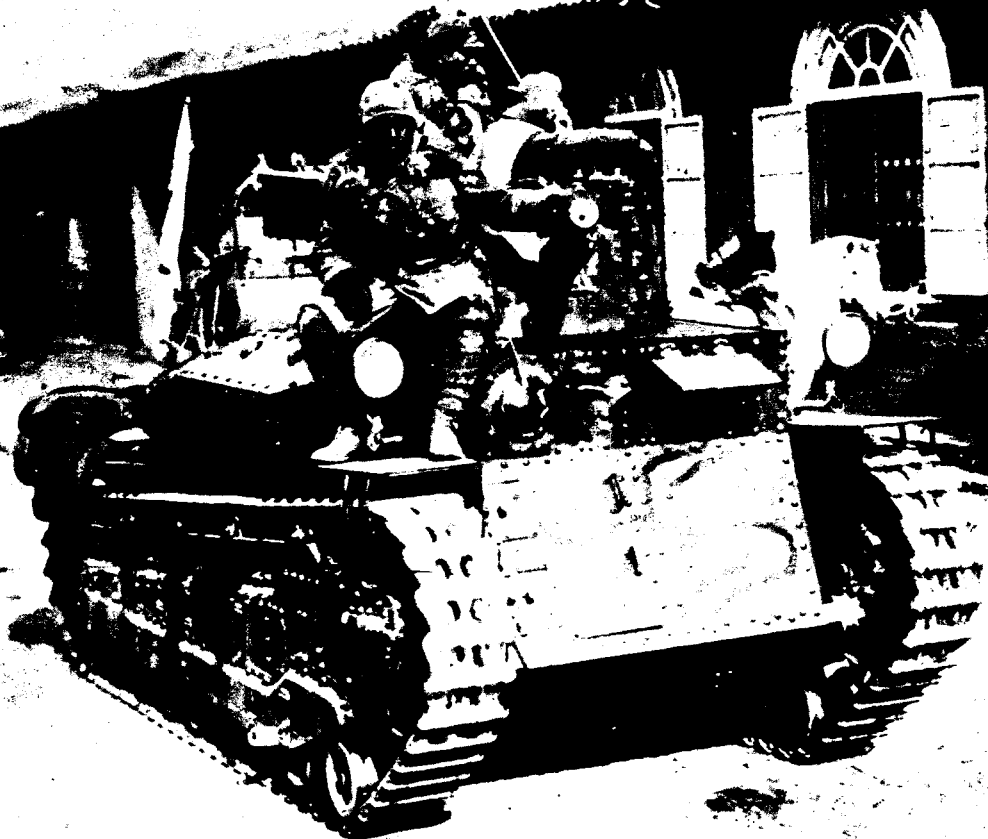

Figure 90. Model 95 (1935) light tank.

Figure 91. Model 89A (1929) medium tank.



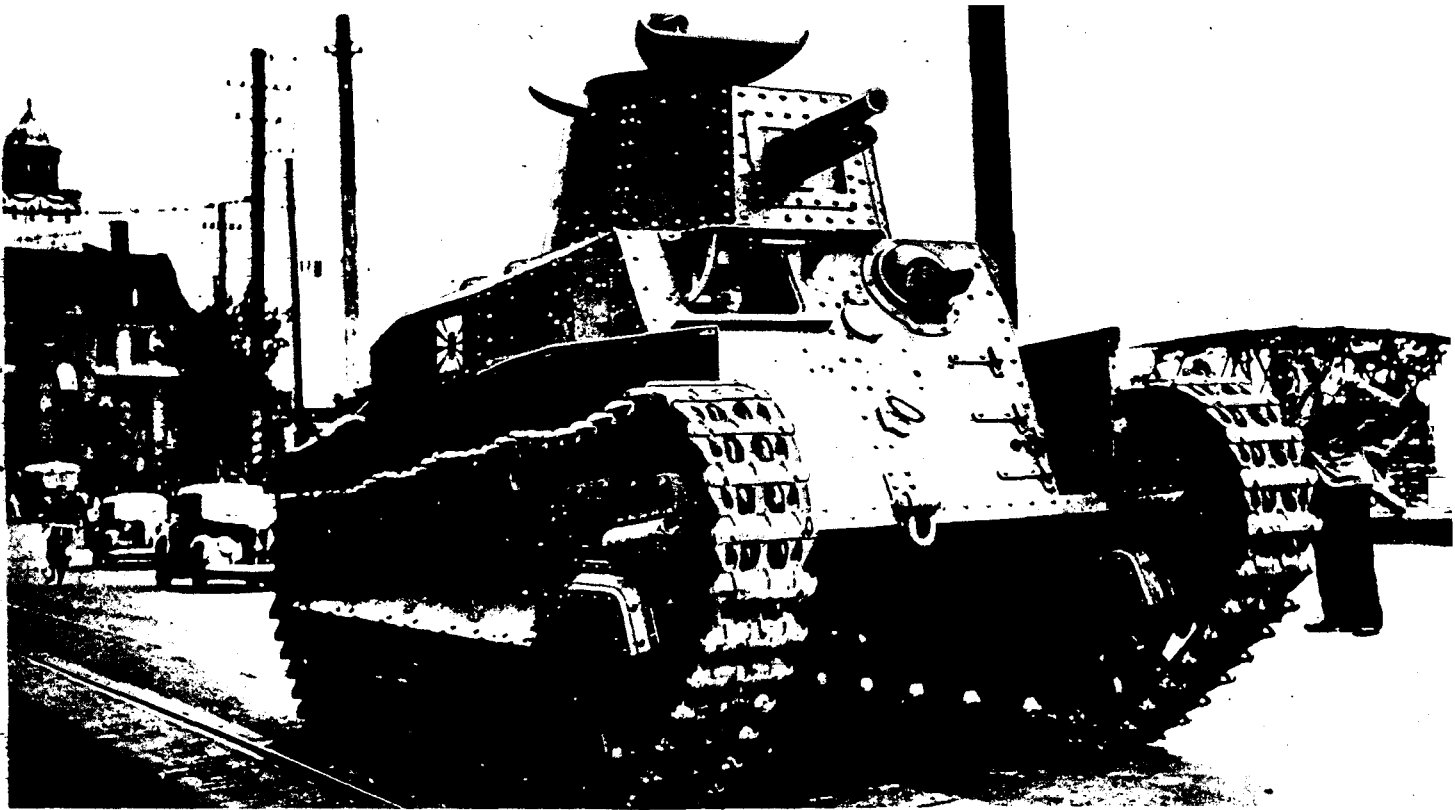
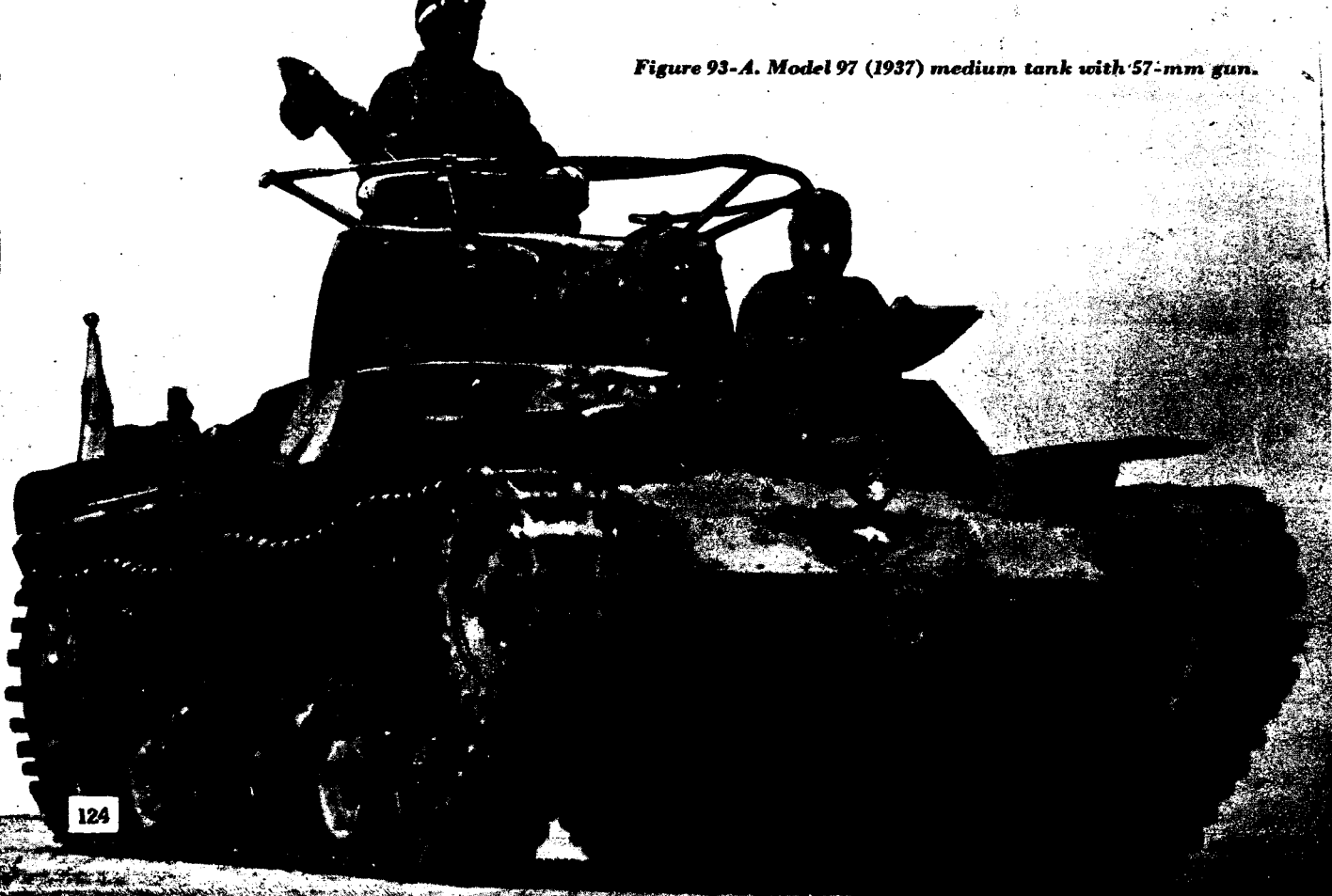

Figure 92. Model 94 (1934) medium tank.

Figure 93-A. Model 97 (1937) medium tank with 57-mm gun.



124

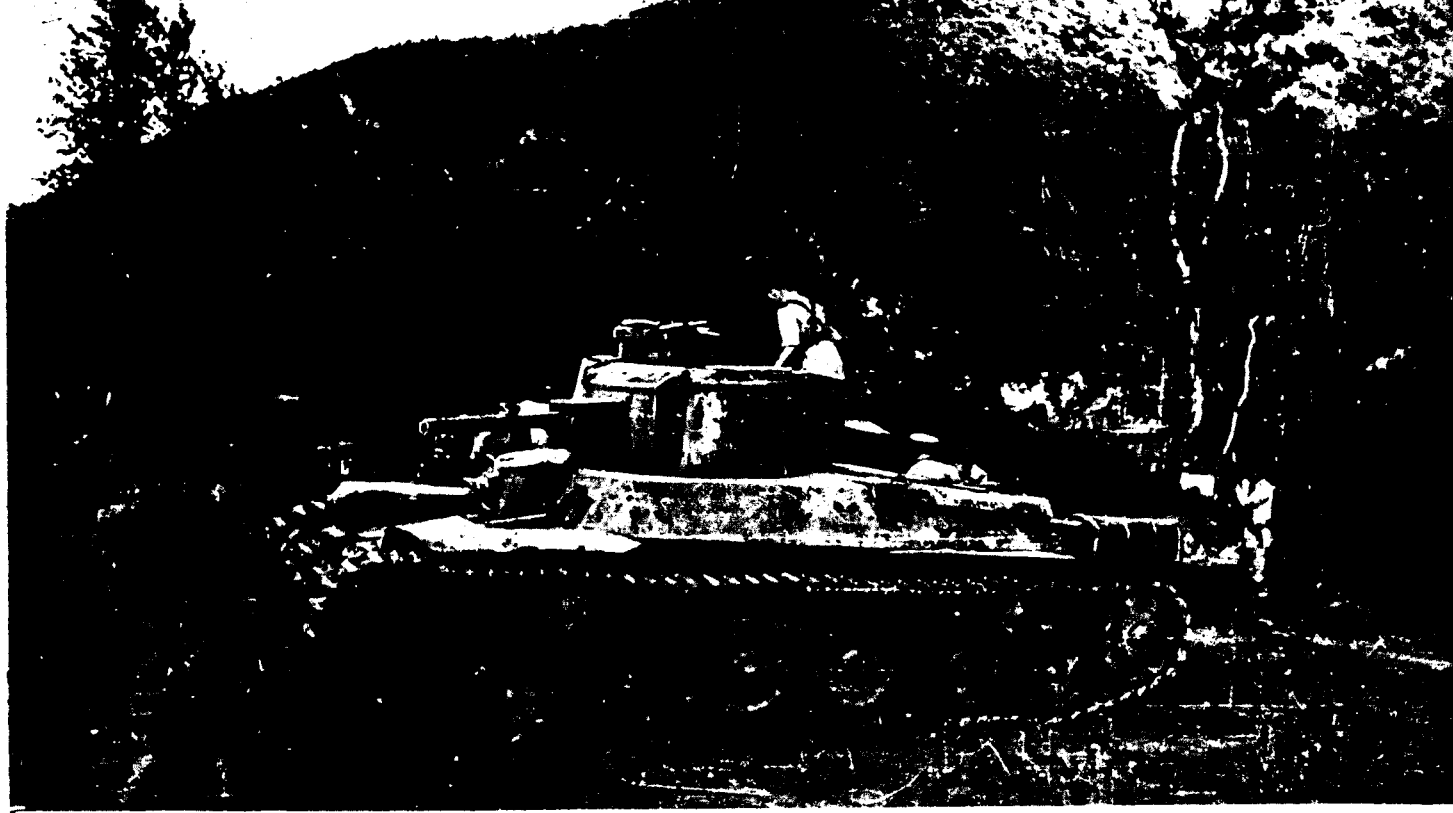

Figure 93-B. Model 97 (1937) medium tank with 47-mm gun.

**Figure 94. Model 97 (1937) medium tank used as pillbox
on Saipan.**



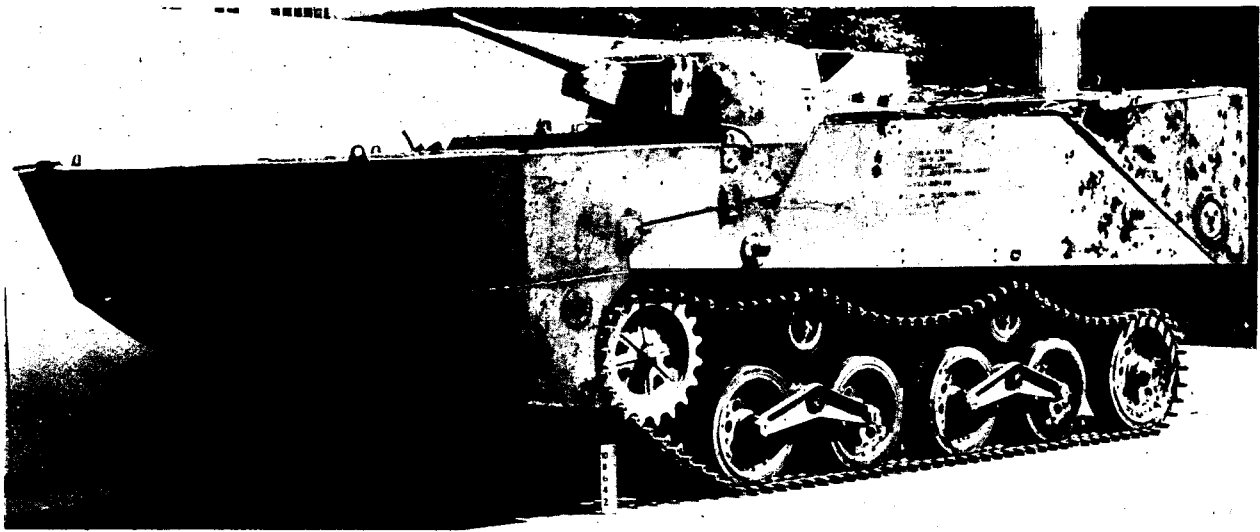

Figure 95. New type amphibious tank.

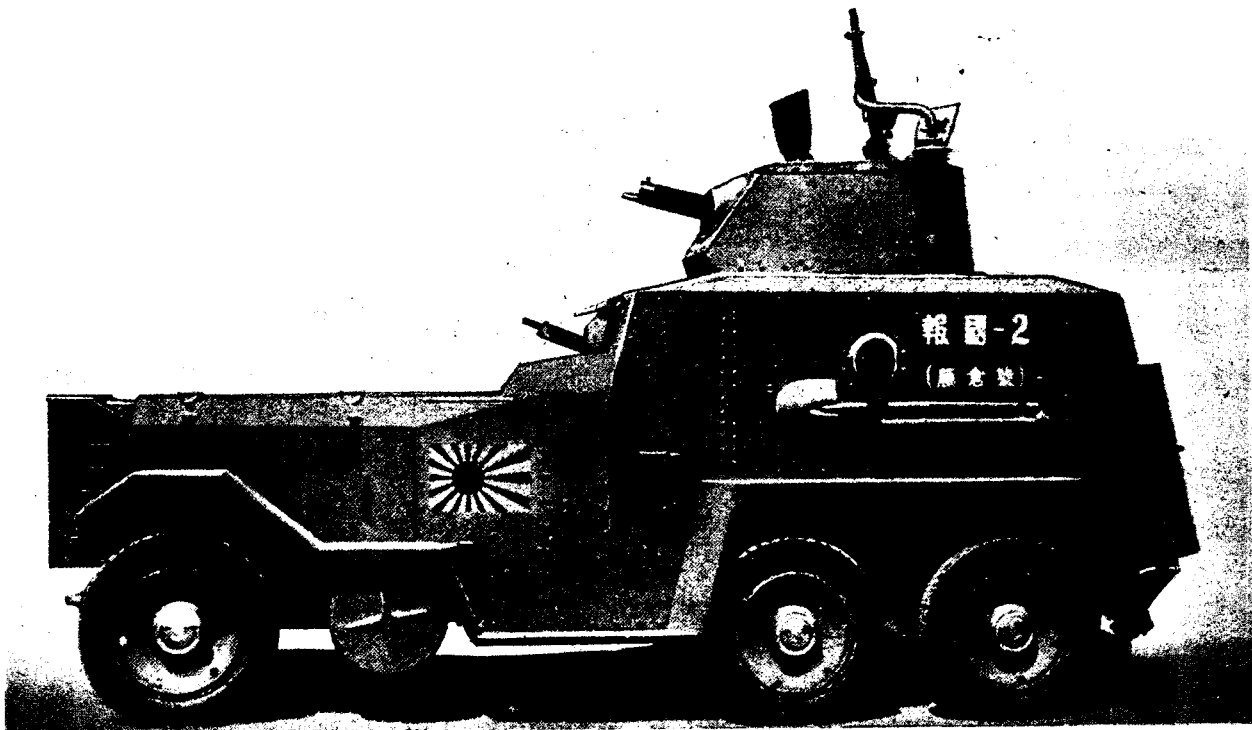

Figure 96. M92 (1932) Navy armored car.

Japanese Tanks—Approximate Specifications

	Weight	Length	Width	Height	Clearance	Crew	Armor	Armament	Speed	Range of action
Model 92 (1932) Tankette	3 tons	10 ft 3 in.	5 ft 3 in.	5 ft 4 in.	13½ in.	2 men	6- to 14-mm (.24 to .55 in.).	1 7.7-mm MG ball mounted.	25 mph	100 miles
Model 94 (1934) Tankette	3.4 tons	11 ft	5 ft 3 in.	5 ft 4 in.	12 in.	2 men	4- to 12-mm (.16 to .47 in.).	1 7.7-mm MG	26 mph	100 miles (estimated)
Model 97 (1937) Tankette	4.5 tons	12 ft	6 ft	6 ft	14 in.	2 men	4- to 12-mm (.16 to .47 in.).	1 37-mm MG	28 mph	
Model 93 (1933) Light Tank	7.8 tons	14 ft 8 in.	5 ft 11 in.	6 ft	15 in.	3 men	Up to 22-mm (.87 in) (reported).	1 MG light (hull), 1 MG light (turret).	28 mph	
Model 93 (1933) Light Tank (Improved)	7.8 tons	14 ft 8 in.	5 ft 11 in.	6 ft	15 in.	3 men	Up to 22-mm (.87 in) (reported).	1 37-mm tank gun, 1 turret MG.	28 mph	120 miles
Model 95 (1935) Light Tank	10 tons (laden)	14 ft 4 in.	6 ft 9 in.	7 ft	15½ in.	3 men	6- to 12-mm (.24 to .47 in.).	1 37-mm type 94 tank gun, 1 7.7-mm rear turret MG, 1 7.7-mm hull MG.	28 mph	100 miles
Light Tank, "Keni"	7.7 tons	13 ft 6 in.	7 ft	5 ft 11 in.	14 in.	3 men	6- to 16-mm (.24 to .63 in.).	1 47-mm gun, 1 MG	31 mph	
Model 89 A (1929) Medium Tank	13 tons	19 ft 3 in.	7 ft 1 in.	8 ft 6 in.	19 in.	4 men	6- to 17-mm (.24 to .67 in), also reported as 17- to 25-mm (.67 to .98 in).	1 57-mm, 1 hull MG, 1 rear turret MG.	15 mph	100 miles
Model 94 (1934) Medium Tank	15 tons	23 ft	7 ft 1 in.	8 ft 6 in.	19 in.	4 men	6- to 17-mm (.24 to .67 in).	1 57-mm gun, 1 hull MG, 1 rear turret MG.	20 mph	100 miles
Model 97 (1937) Medium Tank	15 tons	18 ft	7 ft 8 in.	7 ft 8 in.	16 in.	4 men	8- to 25-mm (.32 to .98 in).	1 57-mm Model 97 gun, 1 7.7-mm Model 97 MG (hull), 1 7.7-mm Model 97 MG (rear turret).	25 mph	100 miles
Amphibious Tank	13 tons	15 ft 8 in (tank only).	9 ft 2 in.	7 ft 6 in.	14 in.	5 men	6- to 12-mm (.24 to .47 in) (hull), 6- to 13.2-mm (.24 to .52 in) (turret).	1 37-mm Model 1 (1941) in turret, 1 7.7-mm MG coaxially mounted, 1 7.7-mm MG in hull forward.		

only four return rollers, and the skirting has been redesigned. There is a door on the left front plate; the driver sits to the right instead of on the left. Otherwise this tank is similar to the Model 89, although the Diesel engine is somewhat more powerful, being rated at 160 horsepower.

The Model 97 (1937) which has been used extensively by the Japanese in Burma has four central bogie wheels paired and mounted on bell-cranks, resisted by armored compression springs. Each end bogie wheel is independently mounted, and there are three return rollers.

An improved Model 97 tank, first reported in the Corregidor operations, differs from the Model 97 in the construction of its turret, which is redesigned to accommodate a high-velocity 47-mm gun.

Amphibious Tank

The new Model 2 (1942) special amphibious tank is characterized by the most complete inclusion of new trends in Japanese tank design thus far encountered. Armor is thicker, the tracks are wider, and the idler has been replaced by a trailing idler. Suspension resembles that of Models 94 and 97 tankettes, except for the fact that the compression springs are inside the vehicle. There are four bogie wheels on each side, and the trailing idler serves as an additional bogie. The engine is a six-cylinder Diesel, practically identical with the one mounted in the Model 95 light tank.

The amphibious tank is armored with a 37-mm tank gun

coaxially mounted with a 7.7-mm machine gun. It is interesting to note that the tank gun has a higher muzzle velocity than that of 37-mm guns found in earlier Japanese tank models.

Flotation of the vehicles is accomplished by pontoons attached by a series of pincer clamps which can be released by turning a handwheel inside the hull. The bow ponton is in six sections, while that of the stern is in five. All openings up to and including the turret ring are sealed with rubber.

Armored Cars

A number of armored cars are in use by the Japanese army. The Model 92 (1932) Osaka armored car is believed to be a Japanese design which employs a standard commercial chassis. The four wheels are pneumatic-tired with the rear wheels dual mounted. The car carries two machine guns, one in front and the other in the rear. Its maximum speed is about 37 miles per hour and its range of action about 150 miles. It is powered by a 4-cylinder gasoline engine. This car often has been confused with the obsolete Model 25. The Model 25 is of Vickers-Crossley design. It and the M92 6-wheeled Lancaster type armored car are Navy vehicles.

Another car that is widely employed is the Model 93 (1933) Sumida. Designed to run either on railways or hard roads, it has four built-in jacks by which it can be raised to permit speedy removal or attachment of the solid-rubber tires. The car has a machine gun mounted in the turret. It has a 40-horsepower gasoline engine. Its maximum speed is 37 miles per hour on rails and 25 miles per hour on roads.

CHAPTER V. ORGANIZATION OF THE JAPANESE ARMY

In the field organization of the Japanese Army there are *army groups*, which would correspond to U.S. theaters of operations. These, in turn, are divided into *area armies*, comparable with armies in the U.S. military organization. Area armies are subdivided into *armies*, which would have roughly the same place in Japanese military organization that corps have in the U.S. Army.

THE INFANTRY DIVISION

Armies in the Japanese system are made up of a variable number of infantry divisions, and Army troops. Divisions ordinarily are commanded by a lieutenant general, with a chief of staff holding the rank of colonel. Headquarters is divided into a general staff section and an administrative section. The former includes G-1, usually a lieutenant colonel who deals with operations and logistics; G-2, a major who is responsible for intelligence; and G-3, normally a captain who is responsible for supply. The administrative section has intendance (supply), medical,

veterinary, ordnance, and judicial subsections. There also are ordnance and signal detachments and a guards unit, making the total headquarters personnel about 300 officers and men.

There are several types of infantry divisions in the Japanese Army. These may be triangular or brigaded. The nature of the terrain and the tactical mission to be performed determine primarily the type of division organization that is utilized.

Triangular divisions can generally be classified into the standard, the strengthened, and several modified types.

In the standard triangular division—the type most frequently encountered—there are, in addition to division headquarters, an infantry group headquarters, three regiments of infantry, a regiment of artillery, a cavalry or reconnaissance regiment, a regiment of engineers, and a transport regiment. Division headquarters personnel number 300; infantry group headquarters has 50; each infantry regiment numbers 3,845, while the artillery regiment has

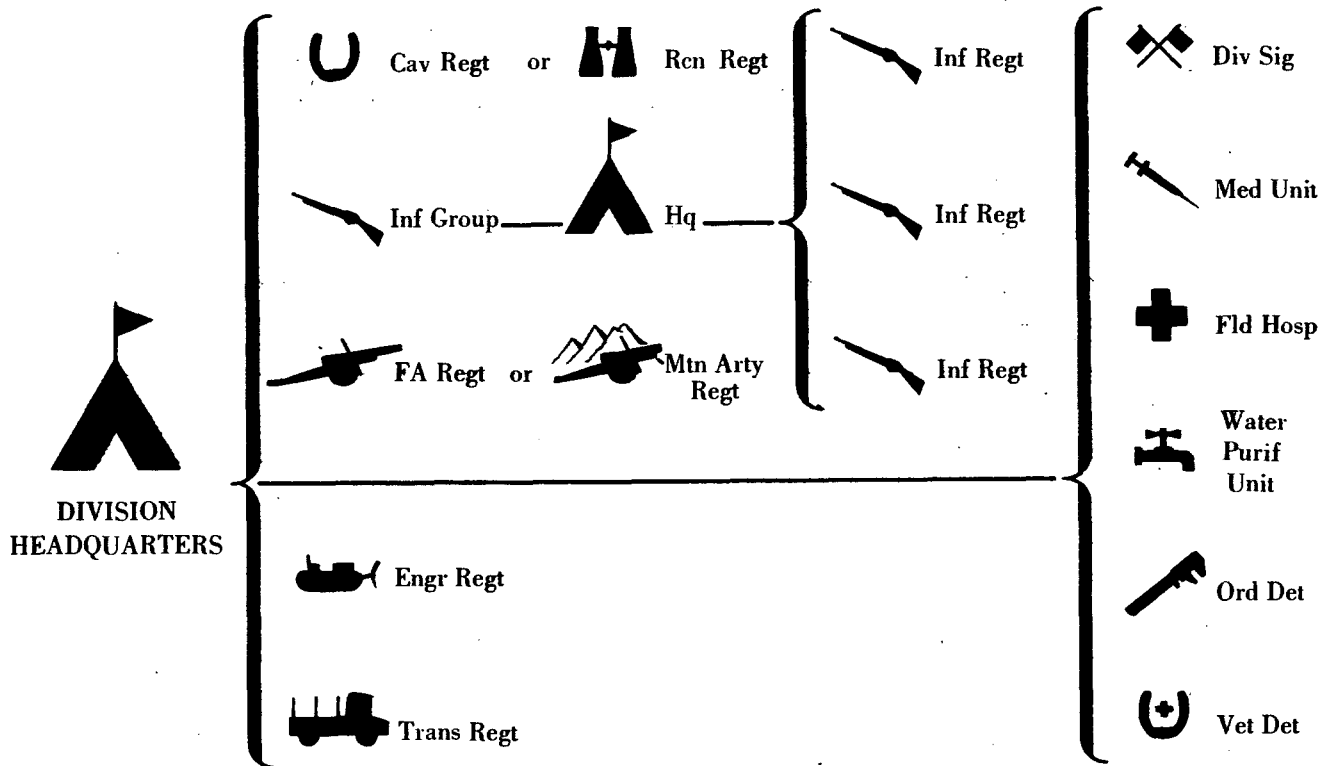

Figure 97. The standard infantry division.

2,300 or 3,400 depending upon whether it is the field or mountain type. The cavalry regiment has 900, the engineer regiment has 950, and the transport regiment 1,800.

The division also includes the following units:

Division Signal Unit.....	250 officers and men
Medical Unit.....	900 officers and men
Field Hospitals.....	1,000 (4 hospitals, 250 men each)
Water Purification Unit.....	120 officers and men
Ordnance Detachment.....	50 officers and men
Veterinary Detachment.....	50 officers and men

Weapons of the standard infantry division are:

Rifles.....	9,000
Light machine guns.....	382
Grenade dischargers.....	340
Heavy machine guns.....	112
20-mm antitank rifles.....	18
37-or 47-mm antitank guns.....	22
70-mm battalion guns.....	18
75-mm regimental guns.....	12
75-mm field or mountain guns.....	36
Tankettes or armored cars.....	7

The chief difference between the strengthened division and the standard division is that the former

is composed of elements consisting of much greater personnel and fire power and contains an artillery group instead of the standard artillery regiment. This artillery group is made up of a headquarters, a regiment of field artillery, and attached medium artillery, usually at least a battalion of 105-mm howitzers. It also may contain an organic tank unit and a decontamination unit for use against enemy gas attack. Thus far this type of division has not been encountered in its complete form.

Strength of the division of this type is considerably greater than that of the standard division. Headquarters has a total authorized strength of 465 officers and men, and each constituent infantry regiment has 5,687. Total strength summary is as follows:

Headquarters.....	465
Infantry Group Headquarters and Signal Unit..	183
3 Infantry Regiments, each 5,685.....	17,061
Artillery Group.....	3,490
Cavalry Regiment.....	950
or	
Reconnaissance Regiment.....	730
Tank Unit.....	720
Signal Unit.....	285
Medical Unit.....	1,085

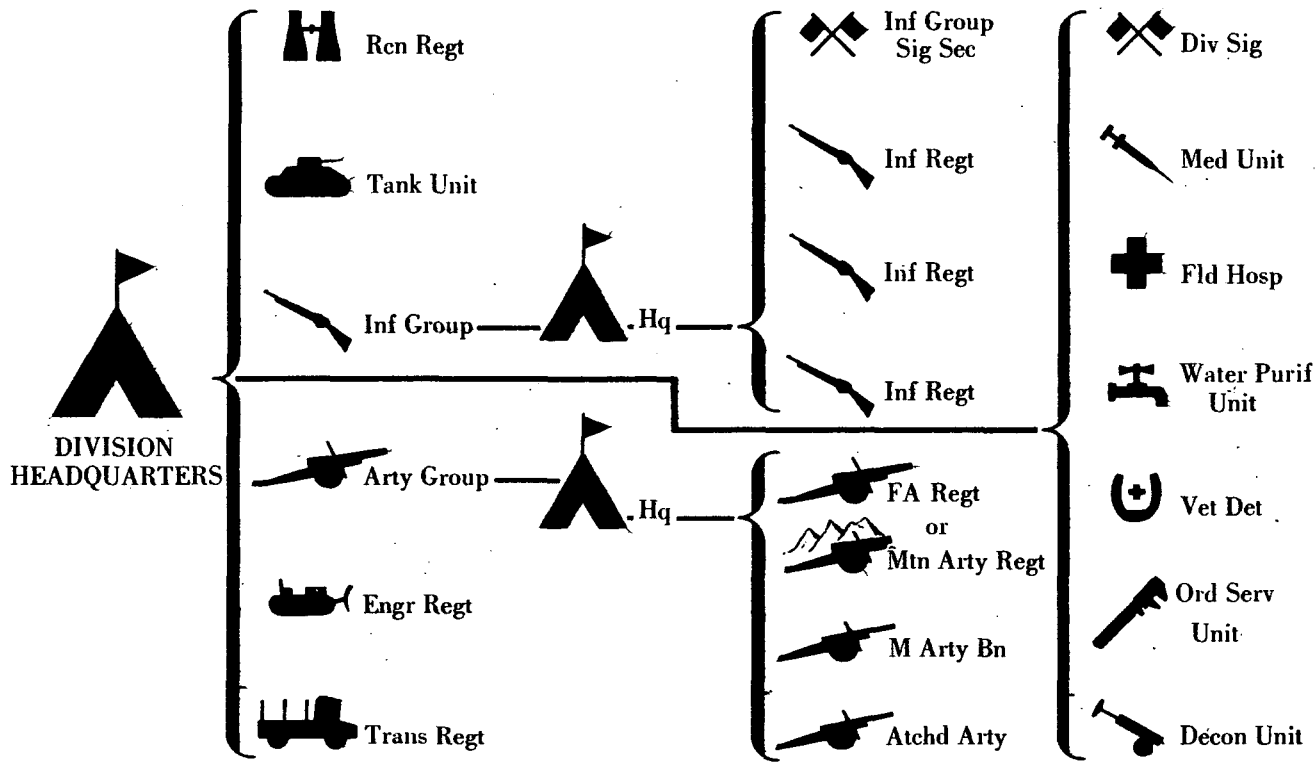

Figure 98. The strengthened infantry division.

Field Hospitals.....	(5 : 200 men each)	1,000
Water Purification Unit.....		160
Ordnance Service Unit.....		185
Veterinary Detachment.....		100
Decontamination Unit.....		190

The increased fire power of the strengthened division is evidenced by comparison of the table of equipment with that of the standard division (see p. 133).

Rifles.....		10,000
Light machine guns.....		405
Grenade dischargers.....		457
Heavy machine guns.....		112
37-or 47-mm antitank guns.....		40
20-mm antitank rifles.....		72
70-mm battalion guns.....		36
75-mm regiment guns.....		24
75-mm field guns.....		12
105-mm howitzers.....		24
150-mm howitzers.....		12
Tankettes or armored cars.....		13
Light tanks.....		20
Medium tanks.....		48

One type of a modified division is the modified strengthened division. Units of this type were known to exist in the early stages of the war and these may

have been forerunners of the strengthened divisions. The modified form of the strengthened division has neither an organic tank unit nor a gas decontamination unit. Then, too, the infantry rifle companies do not have the heavy weapons platoons which are characteristic of those of the strengthened division. Total strength is 24,600.

Another type of a modified division is one which does not have infantry group headquarters, or the artillery, engineer, and transport regiments. It consists of three reinforced infantry regiments organized as combat teams. The total strength is about 15,000.

The brigaded Japanese divisions, sometimes termed special divisions, have been observed in China where they have been used chiefly to combat guerilla activities. These divisions, in addition to division headquarters, have two infantry brigades, each of which is comprised of four independent infantry battalions. There also are signal, engineer, transport, and medical units. Total strength of the special division is 13,000. In addition to small arms and machine guns, a division of this type is equipped with 16 light mortars and eight 70-mm battalion guns.

In both the strengthened and standard triangular

divisions the infantry is under the command of infantry group headquarters, headed by a major general. The chief difference in the organization of infantry group headquarters in the divisions of the two main types is that in the strengthened divisions there is a group signal unit which is absent from group headquarters organization in the standard division.

The standard artillery unit in the Japanese triangular division is the three-battalion, 36-gun regiment of 75-mm field or mountain guns. The standard artillery regiment, with total personnel of 1,920, is horse drawn. In the mountain artillery form all equipment is carried on pack animals, and the strength of the regiment is increased to about 3,000 officers and enlisted men. A motorized version of the field artillery regiment is known to exist in which the strength is commensurately reduced.

In addition to the standard artillery regiment there are mixed field artillery regiments equipped with twelve 75-mm field guns and twenty-four 105-mm howitzers. In a strengthened division, as previously indicated, the artillery group will comprise a medium artillery battalion of 150-mm howitzers in addition to a regiment of 75-mm and 105-mm pieces.

Each division has a cavalry or reconnaissance regiment. Normally, the cavalry regiment has a total authorized strength of 950 and is organized into three rifle and saber companies and a machine-gun company. Reconnaissance regiments, on the other hand, have one cavalry company, two motorized companies, an armored car or tankette company, and a motor-truck company. Total strength of a regiment of this type is about 730 officers and enlisted men.

In the description of the various types of divisions the inclusion of engineer regiments was pointed out. An engineer regiment usually is of the three-company type, although two-company types also are known to exist. The three-company type contains, in addition to headquarters, three companies and a material platoon. Specialists in the construction of tank traps, demolition crews, bridge builders, and other necessary skilled workers are included in engineer personnel. In most cases an engineer company is assigned to each of the three infantry regiments of a division.

So far as is known only strengthened divisions and some modified types include a division tank unit. Other divisions have tankettes in the tankette company of the infantry group or in the reconnaissance

regiment. Division tank units have one light tank company with 20 tanks, and two medium tank companies with a total of 48 medium tanks. There are also a headquarters and a combat train.

About the time of the outbreak of the present war with the Western Powers the Japanese organized a number of independent mixed brigades. Intended for use as shock troops, these brigades contain tanks, antiaircraft artillery, and medium artillery. The infantry element is comprised of three regiments, each with four companies. An amphibious brigade also has been identified, organized apparently as a mobile striking force to aid in the defense of the extended Japanese empire.

REGIMENT AND LOWER ECHELONS

Regimental organization also is determined by the type of division of which the regiment is a component. In the standard regiment, commanded by a colonel, headquarters personnel number 176. There is also a regimental signal company with an authorized strength of 132, an infantry gun company with 122, and an antitank company with a strength of 116. There are three infantry battalions, each with a

strength of 1,099, bringing the total authorized complement of the standard regiment to 3,843.

The component battalions of the standard regiment are organized with headquarters and train, having a total personnel of 147, and four rifle companies, each with a strength of 181. There are also a machine-gun company, with 174 officers and men, and a battalion gun platoon with a strength of 55.

Armament of the regiment is as follows:

Rifles.....	2,130
Light machine guns.....	112
Grenade dischargers.....	108
Heavy machine guns.....	36
37-or 47-mm antitank guns.....	6
70-mm battalion guns.....	6
75-mm regimental guns.....	4

In a strengthened regiment, headquarters personnel aggregate 195 officers and men. There are three infantry battalions, each with a total authorized strength of 1,626. The regiment also includes an infantry gun battalion with 364 officers and men, a signal company with a strength of 150, and a pioneer unit of 100 officers and men. Total strength of a regiment of this type is 5,687.

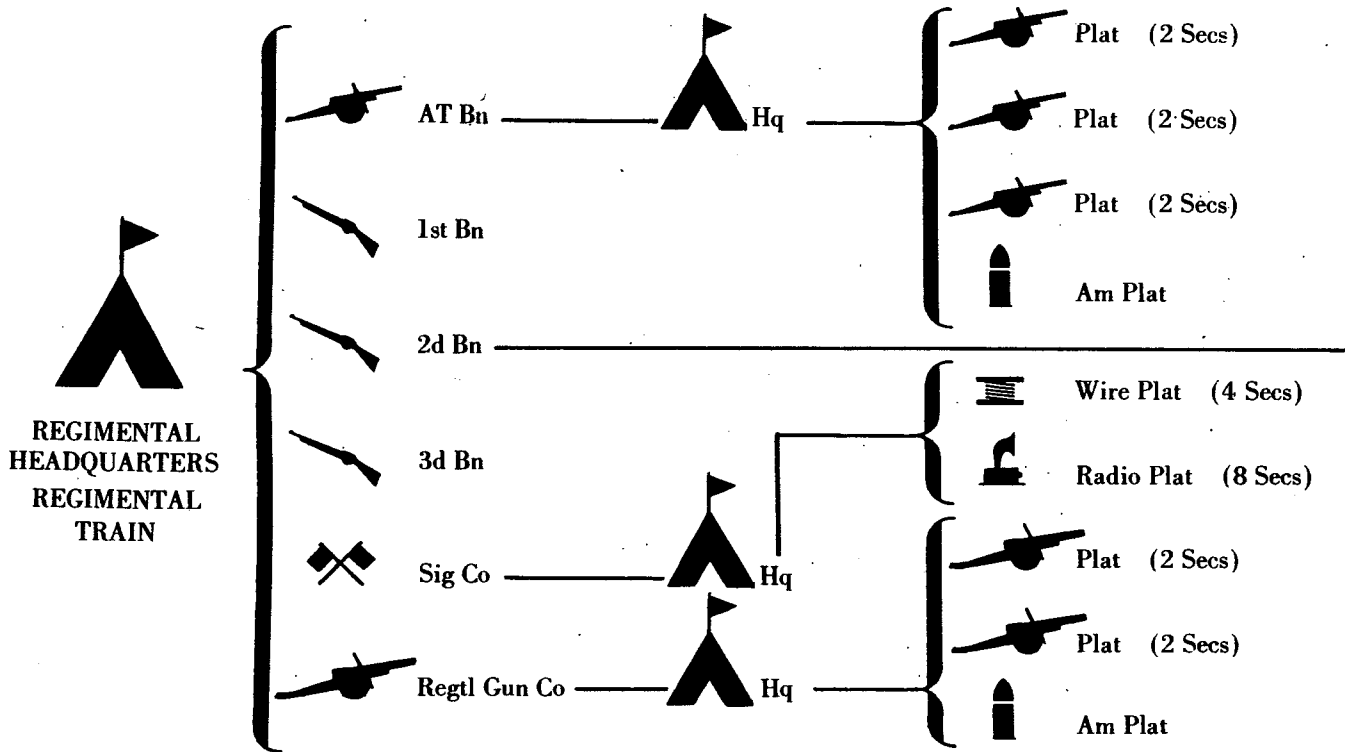

Figure 99. The standard infantry regiment.

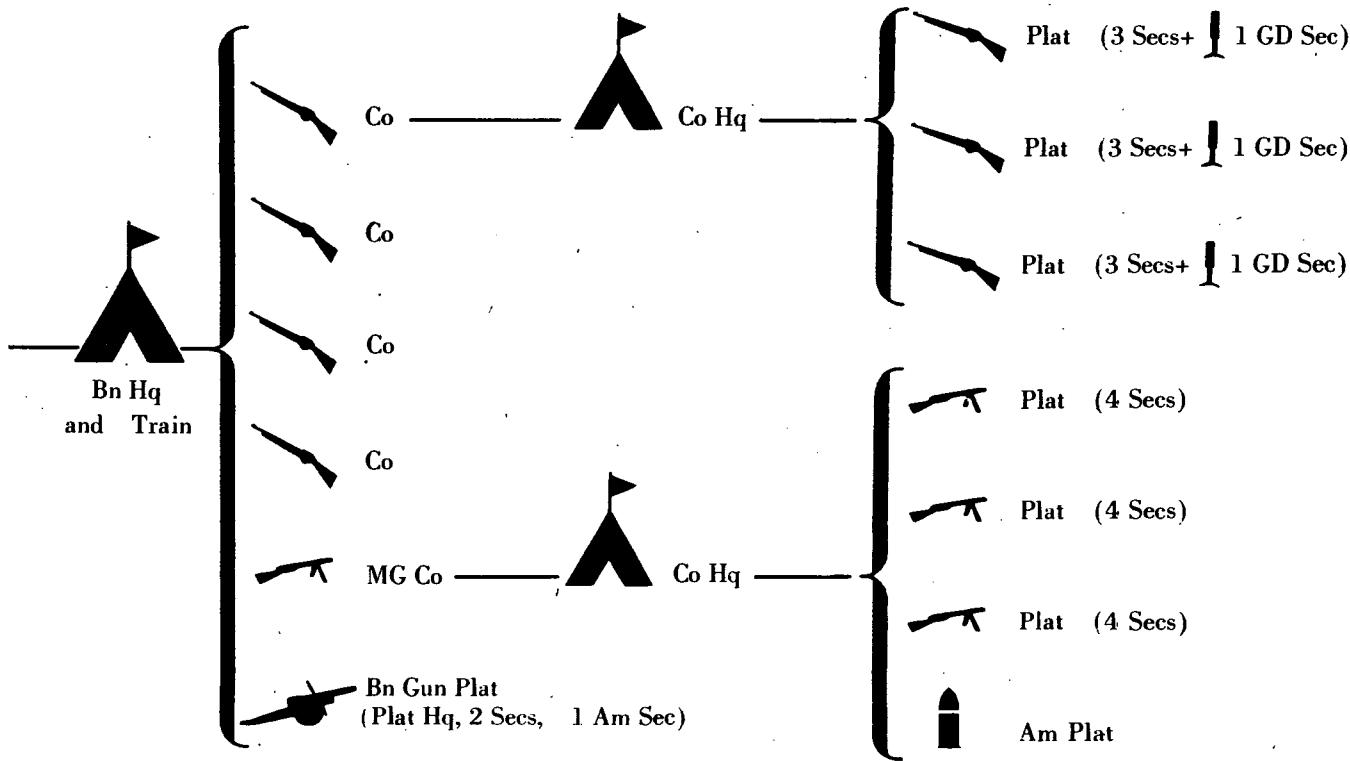

Figure 99. The standard infantry regiment.

Battalions in regiments of the strengthened type have four rifle companies, each with a strength of 262. There is a machine-gun company of 73 and an antitank company of 100, while headquarters and battalion train have a total authorized personnel of 282.

Armament of the strengthened regiment is as follows:

Rifles.....	2,370
Light machine guns.....	115
Grenade dischargers.....	147
Heavy machine guns.....	36
20-mm antitank rifles.....	24
37-or 47-mm antitank guns.....	12
20-mm battalion guns.....	12
75-mm infantry guns.....	8

Regimental headquarters organization is basically the same in both types of regiments. In addition to the staff of the commanding officer and the train personnel, there are an administrative section, a code and intelligence section, an ordnance section, an intendance section, and an antiaircraft section or headquarters guard.

The Infantry Battalion

In studying the organization of infantry battalions in the Japanese Army it again is necessary to distinguish between the standard and the strengthened types. The former has a total strength of 1,100 officers and men. In addition to headquarters and the four rifle companies, each of which has a total strength of 181, there are a heavy machine-gun company and a battalion gun platoon. The strengthened type battalion, on the other hand, has a total strength of 1,626, and, in addition to the components included in the standard battalion, has an antitank company. Also, there is a battalion gun company instead of a platoon as in the standard type.

Comparative armaments of the battalions of the two types are given in the following table:

	<i>Standard</i>	<i>Strengthened</i>
Rifles.....	677	730
Grenade dischargers.....	36	49
Light machine guns.....	37	37
Heavy machine guns.....	12 (8)	4
20-mm antitank rifles.....	0	8
37-mm antitank guns.....	0	4
70-mm battalion guns.....	2	4



HEADQUARTERS
AND TRAIN
(147) 1 LMG



(181)

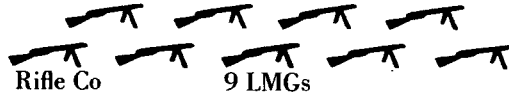

Rifle Co

9 LMGs



9 GDs



(181)

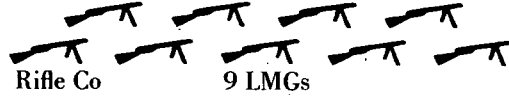

Rifle Co

9 LMGs



9 GDs



(181)

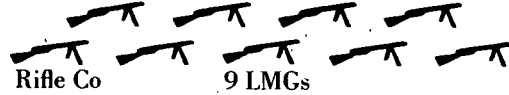

Rifle Co

9 LMGs



9 GDs



(181)

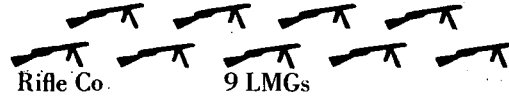

Rifle Co.

9 LMGs



9 GDs



(174)

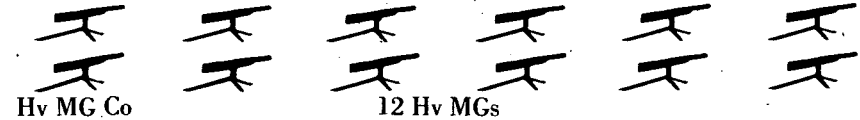

Hv MG Co

12 Hv MGs



(55)



Bn Gun Plat

2 Guns

Figure 100. The standard infantry battalion.

**HEADQUARTERS
 AND TRAIN**
 (283)
 1 LMG, 1 GD

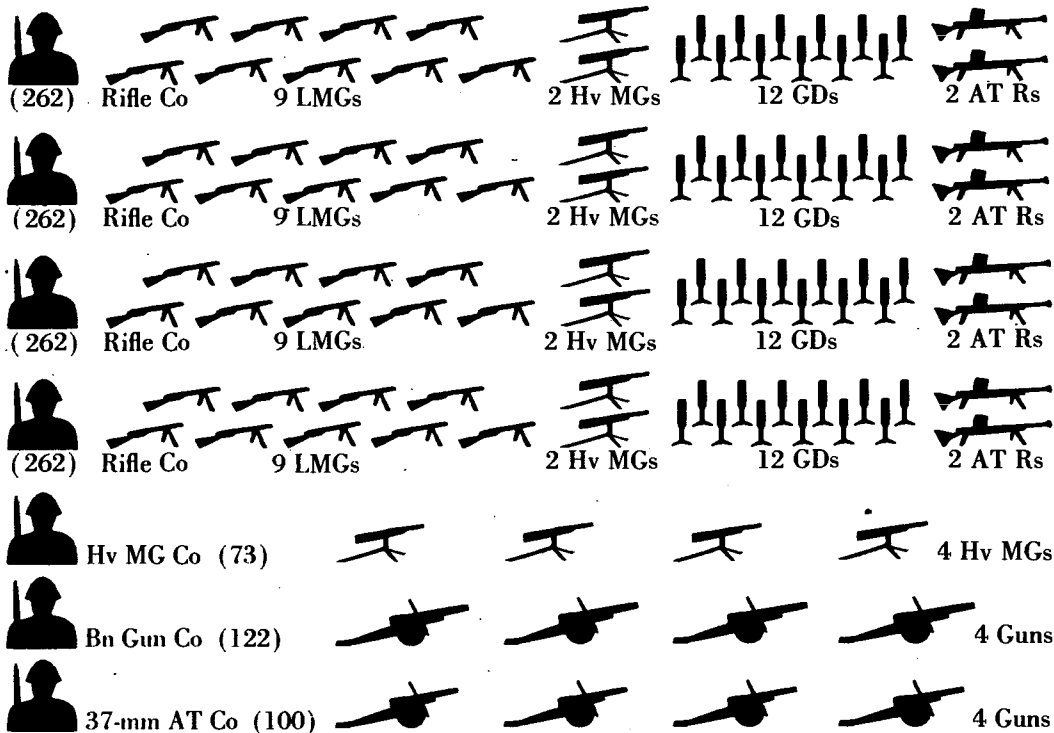

Figure 101. The strengthened infantry battalion.

The standard infantry battalion headquarters comprises 37 officers and men, and the train is assigned a total personnel of 110. Headquarters, in addition to the major in command and the adjutant (usually a captain), has an ordnance officer, an intendance officer, three medical officers, and a veterinary officer in charge of these respective sections. The administrative section has a sergeant-major in charge of personnel, and noncommissioned officers of the same grade in charge of supplies, arms and equipment, and liaison. There are five runners and orderlies, four medical orderlies, and a veterinary orderly.

A battalion machine-gun company may be of two types. In one there is a firing unit consisting of three platoons and an ammunition platoon. Each platoon has four sections armed with three heavy machine guns and one light machine gun. In the second type there are four platoons, each divided into two sections and armed with heavy machine guns, and an ammunition platoon. A battalion gun platoon has a firing unit of two sections each with a 70-mm gun and an ammunition section.

Infantry Rifle Company

Rifle companies in standard battalions have a headquarters personnel of 19, and three rifle platoons of 54 officers and enlisted men each. Each platoon has four sections, three of which have each a light machine gun, while the fourth has three grenade dischargers. Total armament is 139 rifles, nine light machine guns, and nine grenade dischargers.

Companies of the strengthened type may be organized either with or without heavy weapons. In the latter form, the company, in addition to headquarters with a personnel of 19, has three rifle platoons, each with an authorized strength of 62. With the heavy weapons included, there are, besides the aforementioned components, a heavy weapons platoon of 46 and an ammunition platoon of 11. The heavy weapons platoon is equipped with two heavy machine guns and 20-mm antitank rifles.

Platoons and sections are usually the same in both the strengthened and standard divisions. The platoon, which is under the command of a first or second lieutenant, normally consists of four sections. Three sections are rifle sections, while the fourth is a gre-

 COMPANY
 HEADQUARTERS
 (19)



(62) — Rifle Plat ——— 3 LMG Secs 1 GD Sec



(62) — Rifle Plat ——— 3 LMG Secs 1 GD Sec



(62) — Rifle Plat ——— 3 LMG Secs 1 GD Sec



3 LMGs



4 GDs



3 LMGs



4 GDs



3 LMGs



4 GDs

Figure 102. Infantry rifle company strengthened—without heavy weapons platoon.

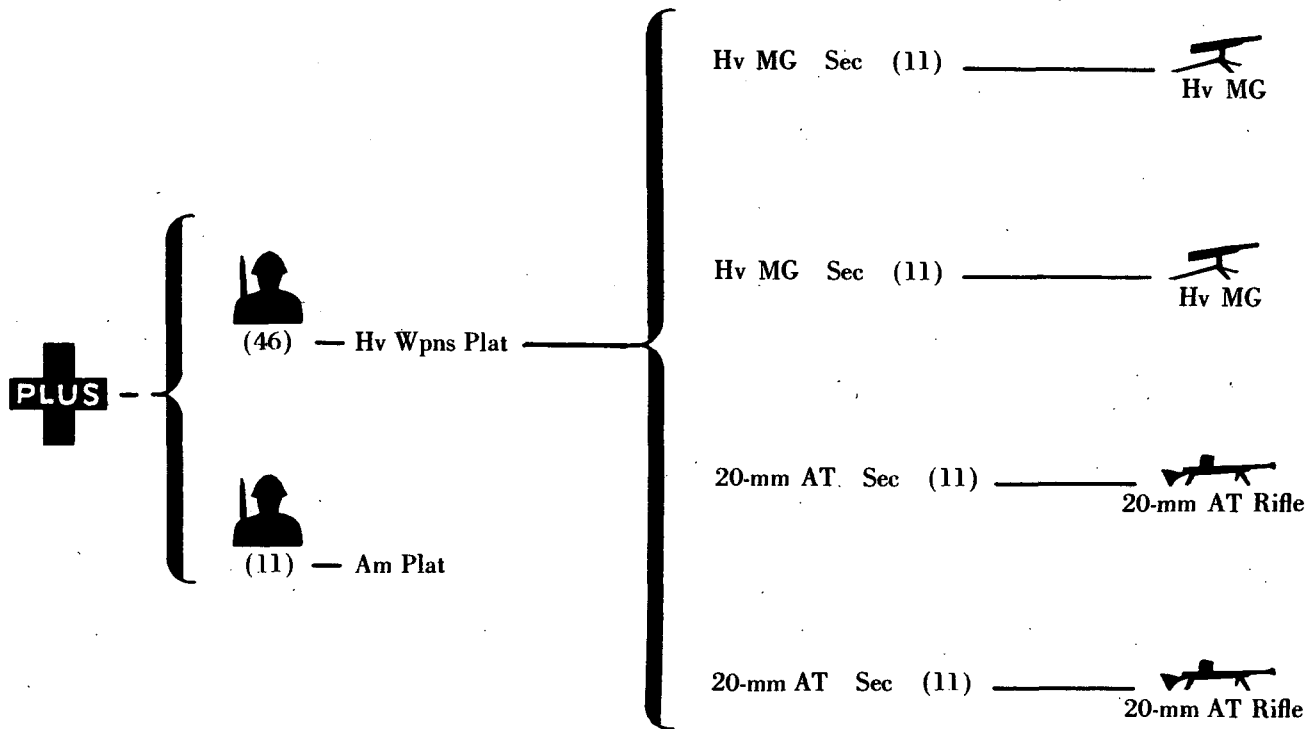

Figure 103. Infantry rifle company strengthened—with heavy weapons platoon.

nade-discharger section. The basic section (*han*) is commanded by a noncommissioned officer and comprises 13 enlisted men. Each section is issued 13

rifles; in addition, each rifle section is equipped with a light machine gun and the grenade discharger section with a 50-mm mortar.

CHAPTER VI. TACTICS: THE JAPANESE ARMY IN ACTION

Since the outbreak of the Manchurian "incident", Japanese military forces have fought virtually every type of action under the widest variety of terrain and climatic conditions. The experience they have gained has led to important changes in their tactical doctrines and practices. In view of their well-known talents for imitation it can be expected that this process will continue, perhaps at an accelerated pace, as Allied victories demonstrate more and more forcefully the need for change.

The Japanese, in their tactical writings and training manuals, emphasize the principle that a simple plan carried out with power, determination, and

speed will disrupt the plans of hostile forces and lead to a quick and decisive Japanese success. The stated aim of every Japanese military action is annihilation of the opposing force, with the achievement of surprise a goal toward which all Japanese commanders constantly strive.

THE OFFENSIVE

Japanese tactical theory and practice insistently stress the superiority of the offense. This concept, of course, is based largely on the unshakable conviction that Japanese infantrymen are inherently superior to

all possible antagonists. This conviction, virtually an obsession, is the product of national vanity, religion, psychological factors, and confidence fostered by victories gained in the early stages of the war.

In accordance with this premise the objective of the Japanese offensive is to maneuver quickly, close with the enemy, and exploit the alleged superiority of Japanese infantrymen in hand-to-hand combat.

Japanese national holidays frequently are chosen for the launching of major attacks. January 1 marks the beginning of a three-day Japanese celebration dedicated to the memory of their ancestors; 11 February is observed as Empire Day, while 10 March and 27 May honor respectively the army and navy. Celebrations in honor of the imperial ancestors are held in the seasons of the spring and autumnal equinoxes (21 March and 23 September). Anniversaries of the birth or death of famous Japanese emperors are observed on 3 April and 3 November; 29 April, birthday of Hirohito, also is observed as a holiday. Ceremonies similar to various American Memorial Days are held on 30 April, and a national thanksgiving is observed by the Japanese on 23 November.

Envelopment is the preferred form of Japanese offensive maneuver for both large and small units. Frontal pressure is brought to bear on the opposing force in a holding attack, while the main effort is concentrated on one or both hostile flanks, depending upon whether the objective of the maneuver is a single or a double envelopment. If a unit as large as a division is engaged in an enveloping maneuver, normal procedure is to direct one or two columns toward the hostile flank or flanks. If a smaller force is involved, the advancing force usually has troops in the rear which are deployed to execute the envelopment while those in front make the holding frontal attack.

Sometimes frontal attacks are made, but the Japanese, for all their rashness in offensive combat, are fully aware of the indiscretion of this type of attack and attempt to avoid it unless there are compelling reasons for its employment. Usually the frontal attack will be made only when the Japanese commander believes that resort to envelopment would allow the hostile force enough time to strengthen its position or to augment its forces and fire power. If such time can be denied by a frontal attack, the at-

tack will be ordered. In frontal attacks the main Japanese effort is made against a sector of the hostile line which is considered to be a "soft spot". Objective of the attack is the rapid and deep penetration of the hostile lines, and to achieve this the attack front is kept in very narrow bounds.

Meeting Engagements

Meeting engagements are deliberately sought by Japanese commanders. Their tactical texts, which go into great detail about this favored type of operation, define the meeting engagement as the collision of two moving forces, or the combat that ensues when a force in motion meets one at rest or not yet installed in prepared positions. In this type of operation great freedom of decision is left to Japanese subordinate commanders who are admonished to seize the initiative and promptly occupy important terrain features.

The Japanese army usually advances in two columns, although three-column advances are not unknown, and resort to one-column movement may be necessary by nature of the road net. In the normal two-column advance the division commander di-

rectly controls the division and the right column, as well as the advance guard sent out by the right column. The left column is under the senior officer of the forces that comprise this group, and he makes his own dispositions for an advance guard. Transport and trains follow in the rear, usually with the advance section of the transport regiment coming first, followed respectively by the unit trains and the remainder of the transport regiment.

Whenever possible the Japanese in a meeting engagement will organize a coordinated attack. Basically, their doctrine in regard to such an attack requires the designation of a line of departure behind which the deployment is made, and emphasizes the need for effective cooperation between artillery and infantry. All attacking elements proceed simultaneously from the line of departure at the prescribed time, unless local circumstances preclude such a procedure.

There are four steps in a Japanese coordinated attack in a meeting engagement. As contact with the enemy is established, the march columns break into smaller ones while still out of range of hostile artillery. Deployment along the designated line of de-

parture then is made. The advance subsequently begins at the stipulated "jump-off" time, with small columns (squads or sections) moving forward; these ultimately complete their deployment to permit firing during the last few hundred yards of the assault.

In the piecemeal attack Japanese units are committed in order of their arrival in the area where contact with the enemy has been made. Control of the attacking forces is decentralized, although the highest echelon commander gives the directions of march and attack. Despite the fact that Japanese attack, the piecemeal form is very common. Indeed, any hostile forces must constantly take into consideration the possibility that they will be attacked almost immediately after contacting a Japanese force—perhaps before they have had time to complete their own arrangements for offensive or defensive tactics.

Attack of Position

In an attack on a fixed hostile position the Japanese try to turn the position by a flanking maneuver. They often endeavor to achieve this objective by passing through terrain so difficult that the opposing

commander considers it impassable and thus leaves himself vulnerable. The fundamental tactical difference between an attack on a position and a coordinated meeting engagement attack is that, in the former, the Japanese offensive forces go into designated assembly positions prior to proceeding to the line of departure whence the attack is launched. Usually three assembly areas are chosen, one for the main force, one for the secondary force, and a third for the reserves. The attack is delivered by two wings—one, the main assault force; the other, the secondary attacking force. Advance from the assembly areas to the line of departure usually is made at night, and the assault is begun at first light.

When enemy positions are surrounded by strong wire entanglements, special assault teams are utilized to cut paths for the attacking echelons. Such teams usually comprise six men and a leader; two members of a team cut the wire, one covers them with rifle fire, while the remaining two are replacements. These squads are integral parts of the "working parties", one of which is established in every battalion. These parties are made up of 20 men commanded by a sergeant-major or a warrant officer. A flame thrower

is part of the normal equipment of such groups.

In attacks of position, Japanese operations normally are characterized by careful work and thorough reconnaissance. The attack is conducted with great boldness and disregard of casualties. Infiltration, envelopment, and pursuit are carried out with great speed, and attacks often are undertaken in the most difficult terrain and under the worst kind of weather conditions.

Deceptions and ruses of every conceivable sort are employed regularly by the Japanese. Shouts, fire-crackers, barking dogs, moving vehicles, and promiscuous firing simulate strength or conceal the true direction of Japanese maneuvers by distraction. English words are exchanged to beguile Allied troops, and false flags, civilian dress, and enemy uniforms all are used to conceal the identity of Japanese troops. Units under the flag of truce, presumably offering to surrender, suddenly open fire on prospective captors. Snipers often lie with the dead, to fire upon the unwary. As the Japanese intention to flout every rule of warfare has become increasingly well known, however, the effectiveness of such tricks has constantly declined.

Night Attacks

The night attack is a favorite tactical maneuver of the Japanese. As a captured Japanese officer is reported to have remarked, "You Europeans march all day, prepare all night, and at dawn launch an attack with tired troops. We Japanese allow our troops to rest all day while we reconnoiter your positions exactly. Then that night we attack with fresh troops."

A number of tactical situations are thought to justify night attacks. They are employed by Japanese units to extend or complete successes won in daylight action. Then, too, they often are utilized to seize important terrain features, possession of which will facilitate the success of ensuing operations. Local night attacks also may be launched to confuse hostile forces or distract their attention from the preparations for the main Japanese effort. It is recognized that in night attacks there inevitably is a serious decline in cooperation among units; direction is difficult to maintain, and mistakes and confusion are far more likely to occur than in daylight operations. The Japanese believe, however, that these

disadvantages are outweighed by the tactical advantages of the night attack.

Favorite hours for Japanese night attacks are those just after dusk or before daylight. The assault phase usually begins within two hours after arrival on the line of departure. Thorough reconnaissance is regarded as necessary for a successful night attack, but is not always carried out in practice. Planning usually is quite thorough. Every effort is made to ensure clarity of march directions, understanding of liaison procedures, and familiarity with identification methods. Provision is also made for the removal of known obstacles by a few men chosen from the rifle squads or by an engineering detachment of about 15 men.

Objectives are limited for a Japanese night attack, with each subordinate commander assigned a clear terrain objective wherever possible. Nevertheless, there is a definite tendency to strive for attainment of overly ambitious objectives, and artillery support is never adequate. Frontages are relatively narrow—a battalion ordinarily will be assigned one of 450 to 550 yards.

The assault is usually made in two echelons with

the second echelon passing through the first. If a battalion is making the assault, there normally will be two rifle companies in the first echelon, and two companies minus one platoon in the second. The remaining platoon is held in reserve to attack the hostile flanks, or to hurl back counterattack if such a maneuver materializes.

Tactically, there is a fundamental distinction between night attacks by surprise and night attacks by force. Only in the latter is artillery preparatory fire laid down. In the attacks by surprise, it is believed that the advantages of surprise more than compensate for the absence of artillery preparations to neutralize enemy strong points, automatic weapons emplacements, artillery, etc.

Instructions to Japanese commanders in regard to night attacks emphasize that adequate time always should be allowed to permit orderly movement into the designated jump-off line. It is regarded as advisable to send a small advance cadre into zones of anticipated hostile mortar and artillery fire. If this fire is not encountered, the attack is pushed at once. Noise is regarded as very effective in confusing the opposing force. Costly experiences with Alliedartil-

lery concentrations no doubt are responsible for the increasing emphasis on warnings to avoid rushing hostile positions until the assault troops have stolen so close to them that opposing artillery and mortar fire cannot be laid down to aid the defensive efforts of the hostile infantry. Every effort is to be made to locate dead spaces in the hostile line which can serve as focal objectives of the Japanese attack. In a night attack in the jungle the Japanese prefer to attack up a slope, to avoid silhouetting the troops.

If the night attack is a battalion operation, patrols are sent ahead for thorough coverage of assigned sectors. An advance group is sent ahead to deal with hostile units and installations which cannot be liquidated by these patrols. On the line of march, heavy weapons come behind each company; they are used to defend positions captured by the attack as well as to fire on hostile searchlights. Light machine guns and automatic rifles are allocated to squads. A reserve, usually of platoon strength, is used to ward off any encircling efforts or to deliver a flank attack should a suitable opportunity be presented.

Night attacks often are made by single companies or even platoons. If a company makes the attack, a

reconnaissance patrol of five to ten men is sent ahead, and forward lookout points are established. Several patrols also are sent ahead to ascertain the opposition's position and strength by drawing premature fire. Soon after dusk on the night selected for the attack, another patrol is sent forward to lay out a line of approach which preferably will follow easily recognizable terrain features.

On the approach march the company advances in a line of columns with constituent squads in very close formation. Patrols are put out in such fashion as to provide all-around protection. The approach continues with maximum stealth until the company is within rushing distance of the hostile force. When the company deploys, the rifle squads of each platoon form a single line. When enemy wire is reached, one squad cuts it and, after passing through, turns to the left. The second squad goes through the break and turns right, while the third squad and the heavy machine guns occupy the space between the other two squads.

Pursuit

Always in offensive operations Japanese units are

expected to be prepared for quick and determined pursuit. The objective of pursuit is to destroy the enemy, and theoretically this is accomplished by pinning him down by direct pressure while one or both flanks are enveloped. If the enemy is observed initiating a daylight withdrawal, frontal pressure is increased, and Japanese pursuit groups are formed from the reserves to attempt to turn the enemy flanks and fall upon his rear. If the enemy, on the other hand, succeeds in disengaging his forces, usually at night, the Japanese commander in pursuit will renew the frontal attack the next day to push through the hostile line of resistance.

Reserves in the meantime are sent against the flanks in attempted turning movements. If the frontal assault succeeds in pushing through the opposing line of resistance, these forces too will be organized into pursuit operations, the highest echelon commander ordinarily will designate probable lines of hostile covering positions where the Japanese forces will pause prior to resumption of the pursuit.

THE DEFENSIVE

Although the defensive is extremely distasteful to

Japanese commanders, there naturally are occasions when they are confronted with such superior opposing forces that even the rashest commander must engage in such tactics. Nevertheless, the defense is regarded merely as a passing phase in combat. Its purpose is to inflict such losses on a temporarily superior hostile force that its initial advantages in numbers, equipment, or position will be neutralized, and the Japanese forces then can pass to the offensive.

In the selection of defensive positions Japanese doctrines and practice conform closely to standards of other armies. Naturally stress is laid upon the utilization of terrain features to advantage, and there is full recognition of the importance of natural and constructed antitank obstacles on both front and flanks.

In most cases the Japanese defense will be organized in two lines—an advance line and a main line of resistance. The advance, or outpost line, is charged with the responsibility of conducting proper reconnaissance to determine the direction, strength, and tactical intentions of the enemy. It also is expected to cover the main line of resistance and prevent its

being surprised. When the hostile attack is launched, the advance line will delay the attack's progress as much as possible before falling back upon the main line. Ordinarily, the advance line will be a series of strong points rather than a continuous line, with the intervals between the strong-points covered by anti-tank and artillery fire. If a division is engaged in defense, the advance line ordinarily will consist of one or two battalions. In smaller units, the proportion will be about the same.

In some cases a line of defense is organized between the advance and main resistance lines to force the advancing enemy to a premature commitment of his forces, to prevent the occupancy of terrain features that would jeopardize the main line, or to delay the enemy attack.

The main line of resistance usually is formed in two sectors, although on a broader front three sectors may be established. The battalion is the normal unit of deployment and will be assigned a front of from 800 to 2,000 yards. If the front is very broad, however, battalion centers of resistance for all-around defense will be organized, with each battalion assigned a front of about 3,000 yards. Depth of the main line

of resistance varies from about 700 to 1,500 yards. Automatic and antitank weapons are echeloned in depth in this zone.

Counterattacks

Japanese commanders are eager to initiate counterattacks to atone for the ignominious defensive role they have been compelled to assume. In fact, they believe that the fundamental purpose of defense is merely to await the moment when the attacker's forces are so disorganized that a quick and decisive counterblow can be delivered. In almost every situation the defensive force will have counterattack units in readiness, and every defensive plan will include directions for the conduct of such maneuvers.

Japanese counterattacks usually are directed against the enemy's flanks and ordinarily will be quick and violent. Heavy mortar fire usually is laid down as preparation; this may be so intense that the enemy is forced to abandon his newly won positions even before the Japanese counterattack is launched. Often the major counterattack will develop from a series of local attacks carried out by groups of from eight to ten men each. Naturally, it is difficult to

ensure even a reasonable degree of coordination under such circumstances, and there have been numerous occasions when Japanese units have been cut to pieces because of their excessive eagerness to counter-attack. Indeed, in some cases Japanese troops forced out of defensive positions have counterattacked immediately without a semblance of coordination or preparation, and have been virtually annihilated.

Delaying Actions; Withdrawals

Heavy hostile pressure may lead to a decision to organize for delaying action. The fundamental purpose of such Japanese action is to avoid decisive combat with the enemy while, at the same time, contact with him is maintained. Successive lines of resistance are designated. Mobile forces well equipped with automatic weapons and artillery fight the delaying action, while the bulk of the reserves falls back to reconnoiter and occupy the next successive resistance line toward which the forward elements fall back.

If hostile pressure becomes so great as to necessitate a Japanese withdrawal and disengagement of main forces during daylight, a local covering force con-

stituted from the reserves is set up to cover the flanks of the line of retreat. A general covering force also is organized from the reserves, behind which the main elements are formed into march columns for the withdrawal. If on the other hand the withdrawal is made at night, a "shell"—a thin line of infantry heavily supported by automatic weapons and a small amount of artillery—is left behind, and the main body forms to serve as a cover. Personnel of the "shell" are expected to sacrifice themselves, although the artillery will displace to the rear just before daybreak.

Defensive Positions

In all the combat areas where Japanese troops have been engaged they have shown great skill in the construction of fixed defensive positions. These are built to afford a strong defense in both width and depth. Wherever possible, installations are made strong enough to withstand artillery fire and aerial bombing. Each position ordinarily will be capable of independent, all-around defense, and great care is taken to ensure the most effective use of available fire power. Machine-gun emplacements, pillboxes, bunk-

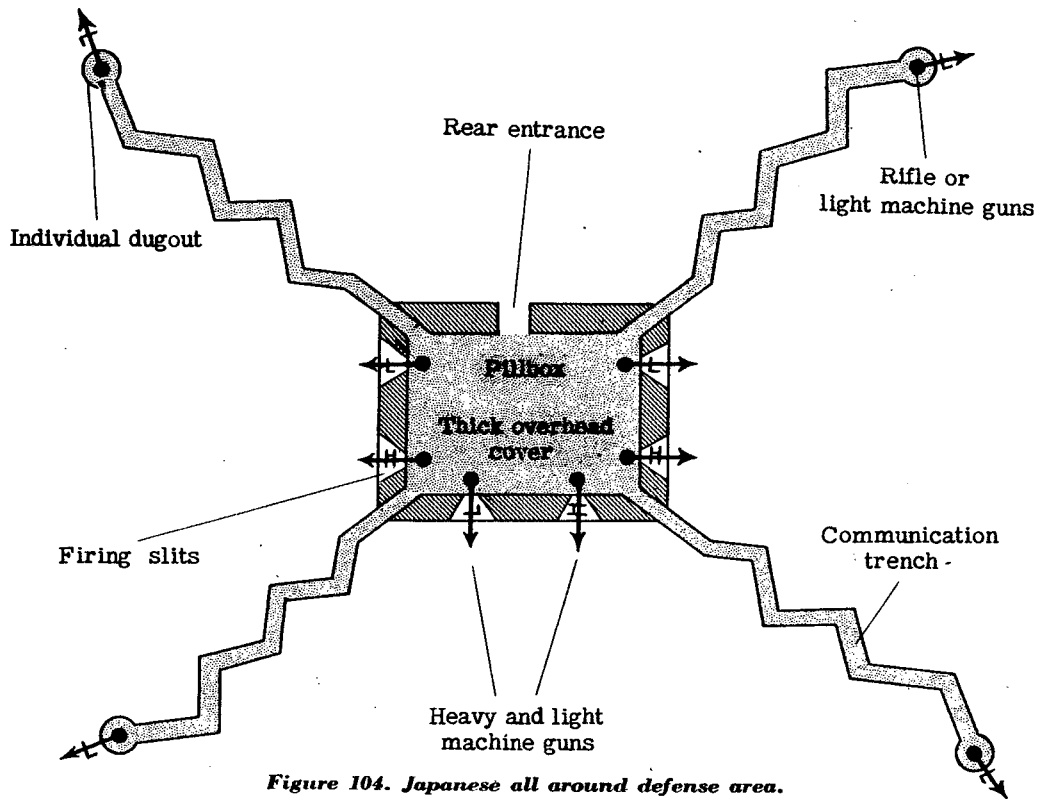

Figure 104. Japanese all around defense area.

ers, and other strong points that may be built will provide a highly integrated defensive network wherein each position can be covered by fire from adjacent ones, and, if a position is temporarily lost, it can readily be regained by counterattack.

Positions will be camouflaged with maximum cunning. Construction principles require that suitable living quarters be erected immediately adjacent to the defense points and properly protected. Naturally, suitable facilities for the storage of food and ammunition will be provided, and the defensive network must be located near an assured water supply.

Japanese doctrine prescribes that "even the smallest unit will prepare deeply entrenched and strong positions against the expected attack", but cautions, "it is most important not to adhere blindly to set forms in construction work, but to adapt such work to fit the tactical situation."

Construction of Japanese defensive positions is a progressive process. Units which assume a defensive mission dig immediately a series of foxholes. Then, if there is time, these are joined together by communication trenches to form an integrated network of rifle pits and machine-gun emplacements. The final



Figure 105. A well-built and concealed pillbox.



Figure 106. Japanese machine-gun emplacement.

phase is marked by the construction of pillboxes, bunkers, and other types of strong points. When the organization of the defensive position is completed, the installations are immune to almost everything but direct hits by delayed-action artillery shells and bombs.

In general, Japanese defense structures will be well sited to provide fields of cross fire and all-around defense. They will be most adroitly camouflaged and connected by tunnels or trenches. Local materials will be used for the most part in their construction. Coconut logs and coral rock have been used most extensively and have proved very satisfactory, since they are strong and do not splinter dangerously.

Pillboxes usually are built over or near dugouts to which personnel can flee in the event of a heavy artillery concentration or aerial bombardment. Some have forward and rear compartments—the forward compartment used for firing, the rear for storage of ammunition and other supplies. On New Georgia, Solomon Islands, the pillboxes had upper and lower decks. The upper deck was used for emplacement of machine guns; in the event of heavy enemy bombardment the gunners could drop through a trap door into

the lower compartment until the fire abated.

Reinforced concrete pillboxes were vital parts of the elaborate beach defense system on Betio Island, Tarawa Atoll. The walls of these structures were from 12 to 16 inches thick, and the concrete was reinforced with steel rods one-half inch in diameter. These pillboxes were sited somewhat ahead of the beach barricade, to deliver frontal fire covering the tactical wire and flanking fire covering the front of the barricade.

Rifle and machine-gun positions which formed the primary beach defense on Betio Island were controlled from steel pillboxes spaced about 300 yards apart around the perimeter of the island. These steel boxes were prefabricated, hexagonal truncated pyramids with double steel walls, each wall of which was a quarter-inch thick. Space between the walls was filled with sand. Inside were an upper and a lower compartment, the upper used to house an observer or command officer, the lower compartment used to afford emplacement facilities for two machine guns. It apparently was the intention of the Japanese to cover these steel boxes with concrete, for one was found capped by 12 inches of this material.

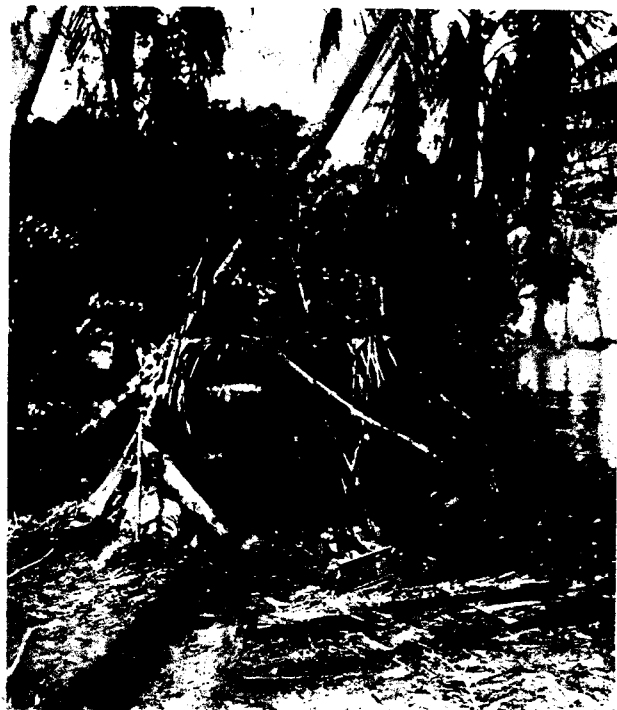

Figure 107. Pillboxes used in defense of Torokina.



Figure 108. Pillbox at Buna.



Figure 109. Concrete pillbox on Guam.



Figure 110. Cleverly concealed concrete pillbox under a Saipan building.

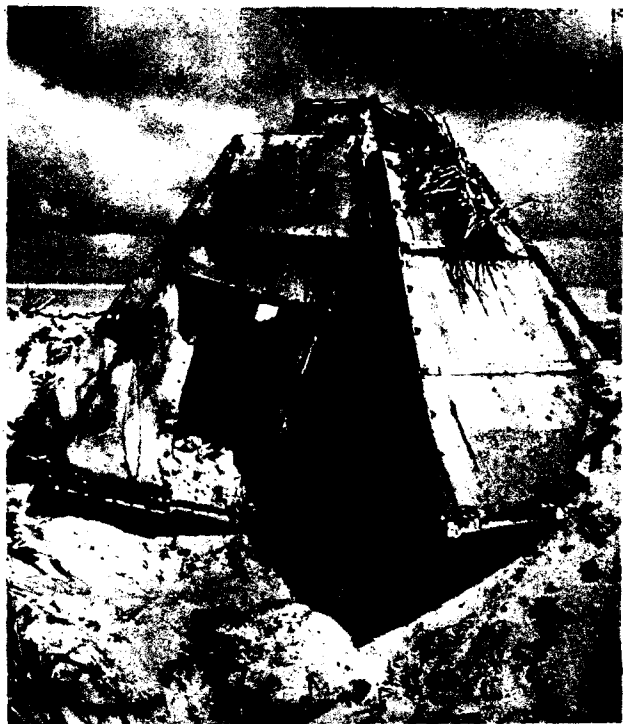

Figure 111. Steel pillbox on Tarawa.



Figure 112. Entrance to pillbox on Tarawa.

Bunkers are constructed above or below ground, depending upon the water table. They usually are built of logs and coral rock and will be from one to 6 feet above the ground. Oil drums filled with earth or sand often are employed to provide additional reinforcement for the walls. Different types of entrances are used; some bunkers are entered directly from fire trenches, others are entered from the rear through tunnels. In any case, the entrances are angled or protected by fire walls to prevent the enemy from tossing grenades into them.

The bunkers defending Buna, Papuan New Guinea, which were situated above ground, were constructed over a shallow trench as a base. Some were 40 feet long; many, however, were only from 6 to 10 feet in length. A framework of columns and beams was built over the base trench and the walls then were revetted with coconut logs as much as $1\frac{1}{2}$ feet thick. Two or three courses of logs laid on top provided the ceiling for the bunker, the walls of which were strengthened with earth and sand-filled oil drums. When completed, the entire bunker was covered with earth, sand, and short logs. Jungle vegetation then was grown over the structures, making them almost im-



Figure 113. Embrasure of Japanese pillbox on Tarawa.

possible to discover until advancing troops were directly upon them. The bunkers were used mainly as shelters during aerial and artillery bombardments, but they had fire slits for machine guns and rifles. Such fire slits, 8 to 12 inches high and 4 feet long, were located just above ground level.

Shelters are used primarily for personnel, and often are located in barracks and headquarters areas to provide a place of refuge for large groups of personnel during heavy enemy artillery or aerial bombardments. On Makin Island, Gilberts group, the dugouts were 20 feet long, and their tops were covered by two or three layers of heavy coconut logs. On Betio Island they were built of alternate layers of coconut logs and coral sand. Side walls and roofs averaged 5 to 7 feet in thickness.

JUNGLE WARFARE

Offensive

Japanese successes in the early phases of the war were won largely because their troops were especially prepared and trained for operations in jungle terrain. In such warfare the weakness of their artillery and

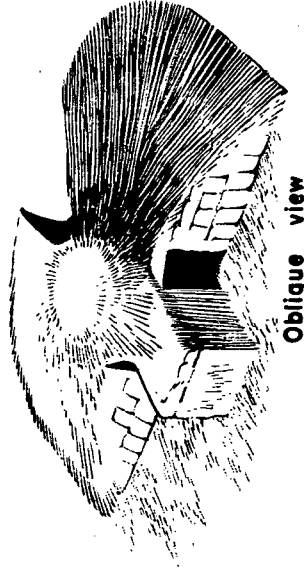
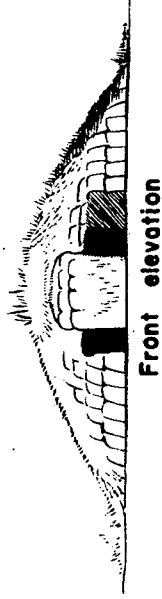
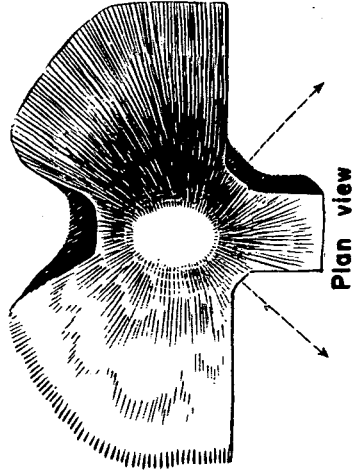

Oblique view

Front elevation

Plan view

Figure 114. Japanese bunkers.

their comparative lack of motorized transport did not tell so decisively against them as would have been the case had operations been conducted in open country. And the ability of Japanese troops to live off the country compensated, to some extent, for weaknesses in their army supply system.

Japanese offensive doctrine naturally is modified somewhat when it is necessary to adapt infantry operations to jungle conditions. The need for adequate reconnaissance is emphasized even more strongly than for other types of combat. Good security for front, rear, and flanks is stressed. The importance of effective patrolling, for both offensive and defensive purposes, likewise receives emphasis in Japanese tactical manuals and studies. As in open warfare, envelopments are favorite tactical maneuvers, but attacks which aim at point penetration are commonly utilized, especially after an enemy strong point or artillery position has been liquidated by a night attack or raid.

Reconnaissance in the jungle normally is conducted by picked and specially trained troops. The function of reconnaissance patrols is to gain contact with the enemy and develop his position. Ordinarily such

patrols will comprise five to ten men who are provided with compasses, portable radio, and mapping equipment.

Advancing Japanese forces in the jungle usually move along the trails in single-column formation. Where no trail is available the march is made along suitable terrain features and the column is preceded by a chopping group to cut the dense foliage. Engineers also are sent ahead when formidable natural or artificial obstacles to the advance are anticipated. The rate of march is about five-eighths of a mile every two hours; from four to six miles ordinarily are covered in a day. The rate of advance actually is limited by the speed with which the heavy weapons can be transported. Direction is maintained by compass and, even in jungle country, the Japanese are well provided with fairly accurate maps. Special care is exercised in crossing clearings in the jungle; often these are traversed by leaps and bounds, and every precaution is taken when the advancing column enters areas where hostile artillery concentrations may be brought down.

In the jungle, as in other types of terrain, the main body is preceded by an advance guard. If the Jap-

anese unit is of battalion strength, ordinarily the advance force will be one company; if a company constitutes the total force, one platoon is used for this purpose.

If contact is made with the enemy, the Japanese advance guard immediately informs the commander of the main body and attempts to liquidate hostile resistance. If this cannot be accomplished, the advance guard deploys or simulates deployment and tries to locate the enemy's flanks and heavy weapons. This is considered essential, since in the meantime the main force deploys and moves against one or both flanks. The objective is to strike the enemy deep in his flanks or in the rear. It is believed that final victory must be won in hand-to-hand combat. Tactics are fundamentally those generally prescribed by the Japanese for a meeting engagement, and even small units follow this basic pattern in actions of this type.

When the enemy is encountered in deployed defense, the Japanese may resort to either of two basic methods. In one procedure they conduct a demonstration along the enemy front with much promiscuous firing of automatic weapons and even firecrackers to simulate strength. While this holding action is

occurring along the front, the main force deploys toward one or both flanks to initiate the usual envelopment maneuver.

When the alternative method is employed, the Japanese "feel out" soft spots in the enemy line. Special efforts are made to locate hostile heavy weapons. Often this is done by opening up with light machine-gun fire until the enemy opens fire in reply and thus reveals his location. As soon as the heavy weapons are located with sufficient accuracy, the Japanese bring heavy mortar fire to bear on them. Usually the mortar concentration hits the hostile positions just as the advancing Japanese reach assault distance. The assault then is delivered on a narrow front, if necessary by two or more assault echelons.

Jungle terrain affords a maximum opportunity to utilize the effective Japanese infiltration tactics. As a holding attack is delivered frontally to confuse and distract the enemy, patrols move to the enemy flanks. The personnel of these patrols are armed with light machine guns and grenades, and are provided with compact rations comprising rice, condensed foods, and vitamin tablets. The patrols wriggle

through presumably impenetrable jungle to get around the enemy's flanks and into his rear areas. Unless the enemy has cleared areas of fire, such infiltrations of his positions are virtually impossible to stop. Sometimes, after reaching suitable positions in the enemy rear areas, the Japanese infiltration patrols dig in, or they may combine with other similar units to build up a force that may be truly decisive.

Snipers almost invariably are sent out; each Japanese squad has two men normally assigned to sniping missions. These have for their fundamental purpose distraction of the enemy from his main tactical effort. The patience of these snipers is almost incredible. They have been known to lie in wait for three days to fire a single shot, and they have no hesitation in firing even when they are certain to be killed immediately by retaliatory fire. They are adroitly camouflaged and select their positions with great skill. Fortunately, however, their marksmanship is so poor, that they rarely are effective at ranges much beyond 50 yards.

Japanese infantry support weapons are employed with daring on the offense, although the restricted

fields of their machine-gun fire in the jungle preclude maximum exploitation of their potentialities. The machine guns usually are sited well forward in pairs, in positions whence they can support the front-line infantry. They are emplaced as secretly as possible and open fire when the maximum surprise effect can be obtained. If antitank guns are available and are not needed for their primary antitank role, they fire upon hostile infantry. Battalion and regimental guns are sited well forward, and are used in the jungle primarily against hostile heavy machine guns.

Defensive

Japanese defense in the jungle follows the general doctrinal concept applicable, in Japanese opinion, to all defensive situations. Defensive lines are expected to bend with the blow of the hostile assault until an opportunity arises to deliver a hard and sudden counterblow to regain the initiative, and even lead to decisive victory.

As in other areas, Japanese defense in the jungle makes use of forward and main defense positions. The forward position has for its main purpose prevention of enemy surprise of the main body. When

contact is made with an advancing enemy, the forward defense line may either withdraw or remain in concealment to harass the enemy. In the event the latter course is adopted, great care is taken by the Japanese to avoid premature disclosure of the location of their automatic weapons. In small unit actions the forward defense will be entrusted to a few snipers who will warn the main body of the enemy's approach. Often snipers will permit the enemy to pass through so they subsequently can be harassed from the rear.

At the main line of resistance the Japanese attempt to achieve tactical surprise by withholding their fire until the last possible moment. Often they do not open up until the enemy's advancing troops have come so close that his artillery and mortar fires have been lifted. On occasion the defensive fire has not been opened until opposing forces were within ten yards of the Japanese positions. If the attacking force is large, however, it will be fired upon when within about 50 yards of the defensive line. Japanese automatic weapons are well sited for defense and ordinarily open fire as soon as the enemy enters their lanes of fire. Machine-gun fire is delivered in great

volume and is supplemented by grenade dischargers and mortars from positions just to the rear of the front line. Certain automatic weapons may remain silent, if not immediately threatened by the enemy attack, and will later open surprise fire.

ARTILLERY AND TANK TACTICS

Artillery Tactics

Japanese artillery tactics as applied thus far in combat theaters have been characterized by pronounced deficiencies and departures from the procedures of other modern armies. Concentrations have been weak in both duration and intensity, and artillery preparation for infantry attacks usually has failed to achieve any adequate neutralization of the hostile targets taken under fire. Although every Japanese triangular division includes a regiment of artillery, and strengthened divisions have a battalion of medium artillery besides, batteries—even single guns—have been committed piecemeal and attached to infantry units. Counterbattery has been quite ineffective; indeed, in jungle areas at least, raiding parties have been used to combat artillery.

Although Japanese artillery doctrine exhibits realization of the major potentialities of artillery fire, in actual practice commanders seem excessively preoccupied with the utilization of artillery in direct infantry support—to the comparative neglect of other legitimate, indeed, indispensable missions.

It should always be remembered, however, that nearly all combat with the Japanese thus far has been in jungle areas. Here, employment of artillery on a large scale has been precluded by the nature of the terrain, and the disadvantages incident to Japanese tactics have been minimized. Recent tactical doctrine in regard to the employment of artillery and trends in combat theaters show, however, that the Japanese have become increasingly aware of the limitations of their artillery. They are taking measures to insure more effective artillery preparation for attacks, as well as to place greater emphasis on counterbattery fire. There also is evidence that provision has been made for higher echelon control to facilitate large-scale committal and control.

On the offensive, Japanese artillery units are imbued with the same offensive spirit that characterizes the infantry. Emphasis on speed of movement and

the constant endeavor to attain surprise, which is so fundamental in Japanese infantry tactics, apply with equal validity to artillery. The paramount consideration is the emplacement of artillery as far forward as possible, in line with the Japanese concept that the major mission is to provide direct support to the infantry attack.

In the envelopment maneuvers favored by Japanese infantry, the artillery usually is emplaced behind the center of the infantry line, from where it not only can fire on the flanks where the major effort is being made but also can support the secondary frontal attack. In the jungle, however, modification of this practice is considered necessary by the Japanese. Here the artillery must fire with trajectories high enough to clear the treetops. The infantry cannot maintain a rapid rate of advance in most cases because of the extreme difficulties of jungle terrain. These two conditions combine to make it virtually impossible for the Japanese to adhere to their doctrine of close fire support unless they emplace their artillery on the flanks of the advancing infantry. By siting their guns in this fashion they allegedly have been able on occasion to lay down their

artillery fire only 50 yards ahead of the infantry.

On the defensive the Japanese allot some artillery support to the advance defense line, but naturally concentrate the bulk of it behind the main line of resistance. Here it is normally emplaced in depth from 1,700 to 2,200 yards behind the infantry line. The largest volume of fire is delivered in the area between the forward defense positions and the main line of resistance, and the major concentrations are fired in front of, and subsequently within, the infantry fire network. Before the enemy reaches striking distance of the main Japanese line, the artillery fires interdiction missions which subsequently are followed by a limited barrage. Only a few of the Japanese batteries or pieces fire these missions, however, for it is considered very important to withhold fire until the enemy are within close range. In the jungle the Japanese emplace their artillery on their flanks for defensive as well as offensive purposes.

Tank Tactics

The Japanese recognize the value and tactical potentialities of armored and motorized units; their armored tactics cannot be taken lightly despite the

inferiority of their equipment and the modest scale upon which it is employed in comparison with the standards of European operations. At least four tank regiments were in existence at the outbreak of the war, and more probably have been organized.

Evidence of increasing armored strength has been found in a document that presents the tables of organization and equipment of a division to which three tank regiments have been attached. These tank regiments in turn are triangular in organization, with three companies to each regiment and three platoons to each company. It should be noted that apparently there is no battalion organization. A total of 135 tanks is assigned, with 45 to each regiment, 15 to a company, and five to a platoon.

Tanks are regarded by the Japanese almost exclusively as infantry support weapons. Personnel of Japanese tank units are trained to emphasize speed of decision, great mobility, rapid concentration of fire, concealment, and effective supply and maintenance as the basic requirements for successful tank action.

In division operations tanks are attached to infantry units and come up at night to designated assembly positions. In a tank-led attack the tanks

move forward in waves, followed by the infantry and covered by artillery fire which has for its main purpose neutralization of enemy antitank weapons. In such an assault the tanks themselves concentrate on knocking out obstacles, automatic weapons, hostile artillery, and the enemy command system.

Recent doctrine apparently envisions the employment of three tank echelons in the offensive operations of a division. The first echelon will comprise two tank companies, each of which is attached to one of the two front-line infantry regiments. The mission of the first tank echelon is to neutralize enemy antitank guns and strong points, to create a passage-way for the assault. The second tank echelon follows about 400 to 500 yards behind. It is made up of four tank companies, each of which is attached to, and controlled by, an infantry battalion. These tanks lead the infantry assault and afford direct fire support. The third tank echelon will remain under the direct control of the division commander and be kept in reserve.

Under favorable circumstances, Japanese tanks may be sent ahead prior to the actual commencement of the attack, to disorganize enemy communications

and destroy important rear installations. They then return to assume their role as support for the attack. There is evidence that the use of "leading tanks" in assault roles is now at least contemplated, and there also have been instances when tanks were used as stationary batteries, particularly in holding attacks on the hostile front while the main attack was delivered on one or both flanks.

On the defense, Japanese tanks usually are held in reserve with the intention that they eventually will be attached to infantry forces for counterattack. They also assume an antitank role in the event that the hostile tanks have moved ahead of their artillery support or have become dispersed to such an extent as to make them very vulnerable to concerted attacks by several tanks.

Armored units include, besides tanks, motorized infantry, engineers, field and antiaircraft artillery, as well as antigas and signal detachments. Tactics of such groups seem similar to those of a large cavalry force. Surprise attacks are emphasized in which the infantry covers the tanks, facilitates their action, and holds ground which has been overrun by the armored vehicles.

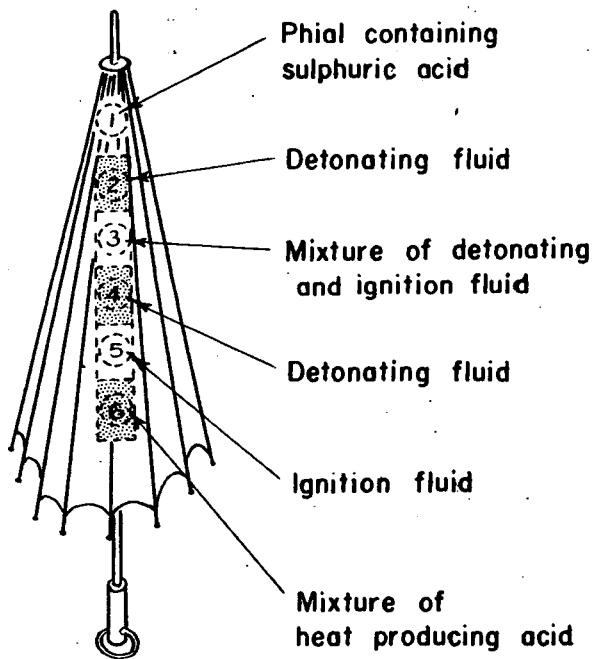

Figure 115. Parasol-type booby trap.

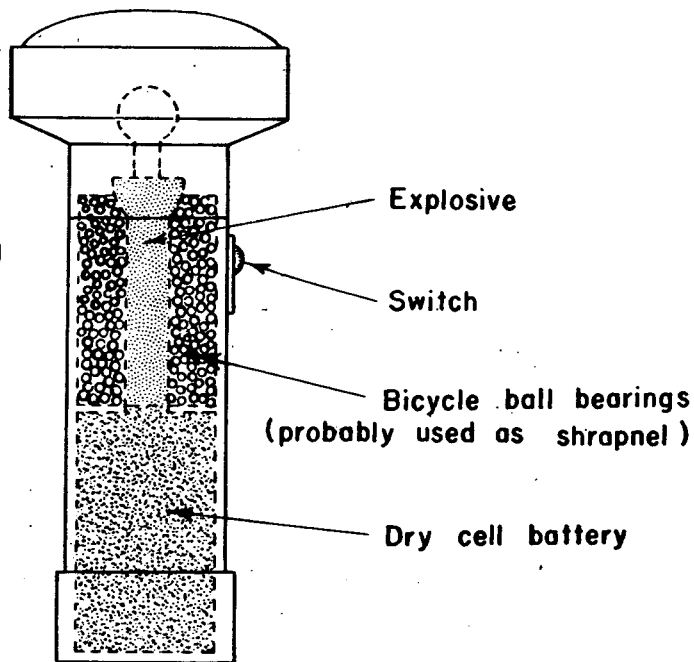

Figure 116. Flashlight-type booby trap.

BOOBY TRAPS AND MINES

Booby Traps

While Japanese booby traps have not been used on a scale comparable with German utilization of such devices, nonetheless they are being employed with increasing frequency and ingenuity. The booby trap, of course, is primarily a defensive weapon designed to retard the enemy's advance, and constantly mounting Allied pressure has forced the Japanese to assume the defensive role despite their strong disinclination for this type of combat. More and more terrain, once occupied by Japanese forces, must be relinquished by them, and it is under such circumstances that resort to booby traps can be anticipated. In the recent Burma campaign 100 Japanese booby traps were laid in an area about 100 by 200 yards.

Early examples of Japanese booby traps include the parasol type, wherein opening the parasol broke an acid vial which, in turn, ignited the detonating and ignition mixtures. A flashlight type was activated by pressing the switch in the normal fashion. Another early and somewhat crude type, intended primarily

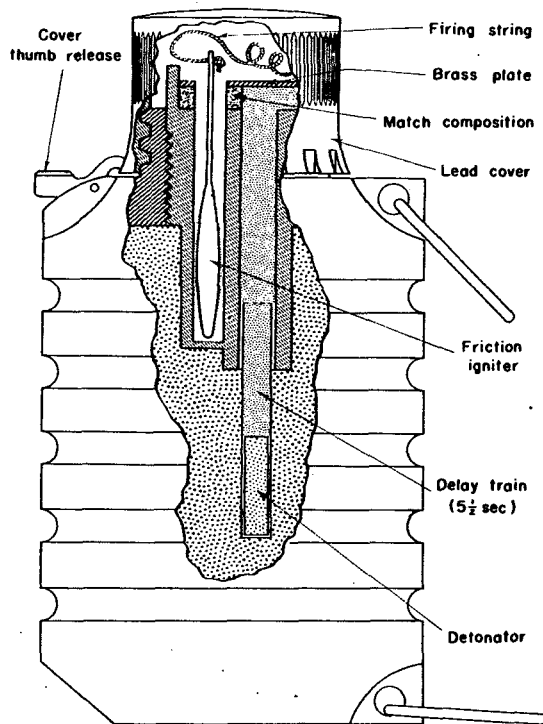

Figure 117. Pull-type hand grenade.

for incendiary action, employed a bottle which, if shaken, brought sulphuric acid in contact with potassium chlorate in the cork. The small explosion thus produced ignited benzene or kerosene.

The basic weapon of many Japanese booby traps currently used is the pull-type grenade. This is $3\frac{3}{4}$ inches long and 2 inches in diameter. It is made of cast iron with five transverse grooves on the outside body, and is fitted with a lead cover. When the cover is removed, a firing string is exposed. A pull on this string pulls a friction igniter between two parts of match composition, thus setting off a $5\frac{1}{2}$ -second delay train. The firing cord can be attached to a cross cord and mounted in various ways for the construction of booby traps.

One of the most widely encountered Japanese booby traps is the tube type. An iron, steel, or even bamboo tube, about 15 inches long and with a diameter large enough to permit the insertion of a pull grenade, is bored with three holes respectively for suspension, safety, and support wires. After the holes are bored the grenade is inserted with the wires extending out of the tube through the holes. Both ends of the tube then are closed with stones or

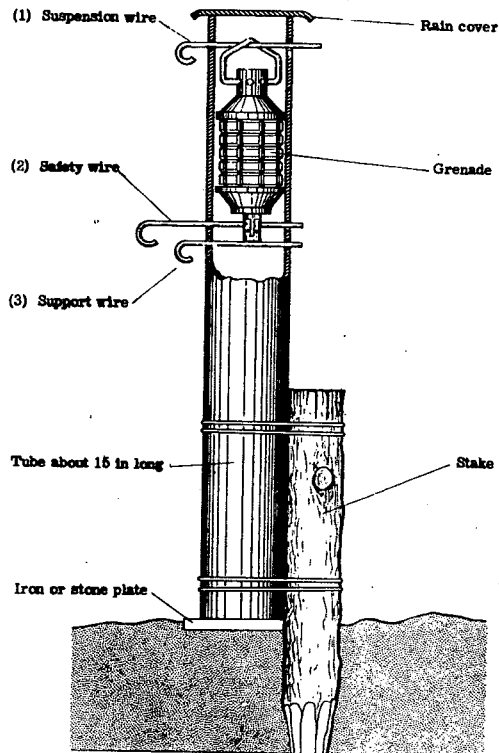

Figure 118. Tube-type booby trap.

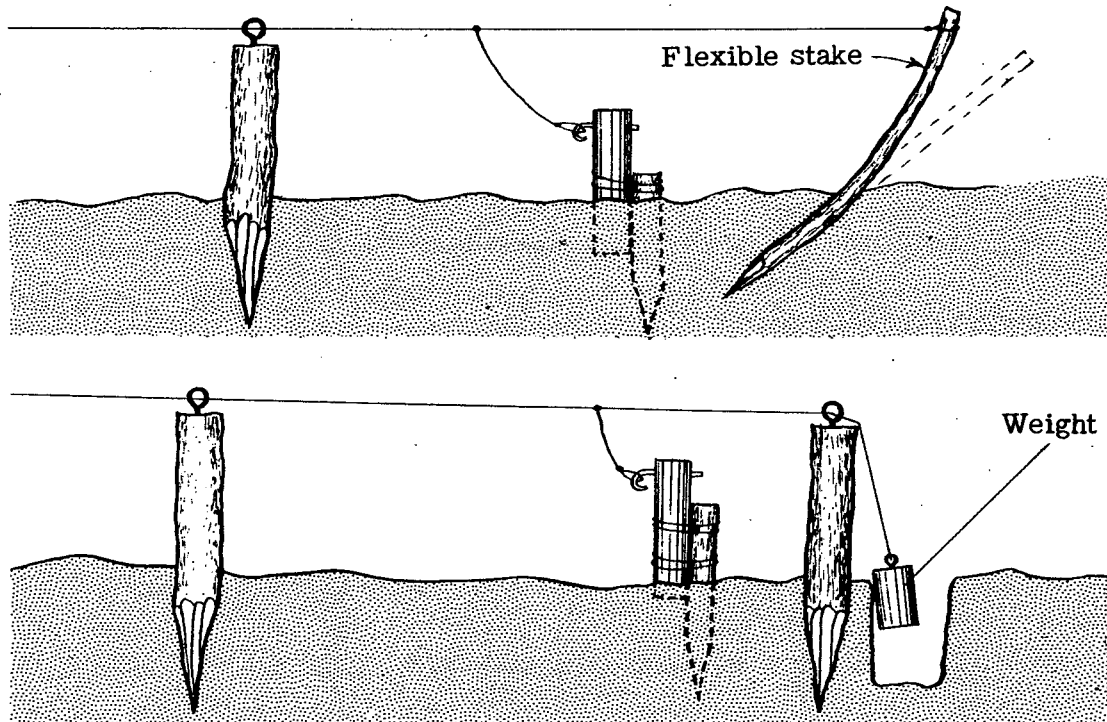

Figure 119. Use of grenade in trip-wire booby traps: Above, using a flexible stake to pull out the suspension wire; below, using a weight for the same purpose.

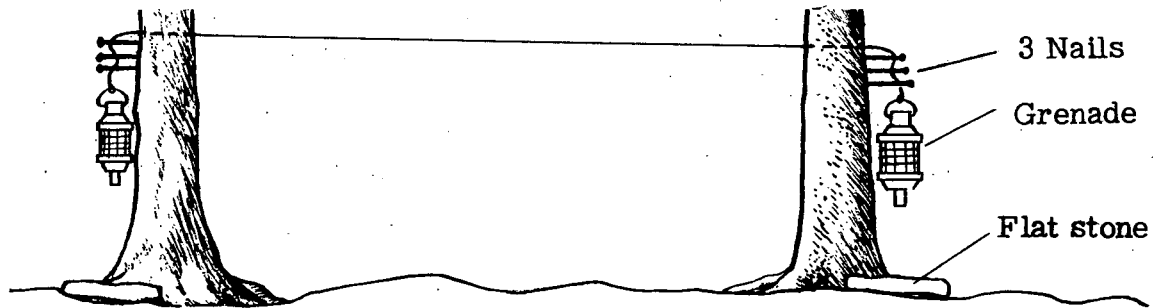

Figure 120. Use of grenades in booby trap, with string stretched between trees.

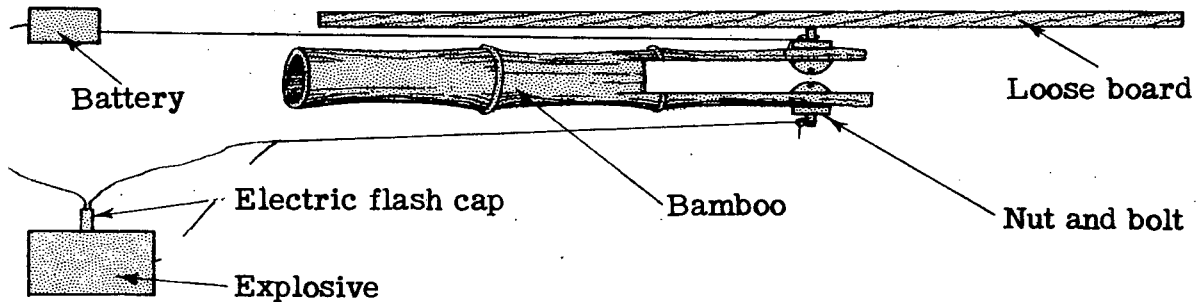

Figure 121. Electrical ignition booby trap.

other suitable materials and the tube is strapped to a stake driven into the ground. The support and safety wires then are removed, leaving the grenade suspended in the tube solely by the suspension wire. When this wire is pulled out, the grenade falls down into the tube. As it strikes the bottom, the pin is driven into the cap and the grenade is detonated within 4 to 8 seconds.

Various riggings have been devised which employ the tube-type grenade installation. A cross wire at the height of about a foot is attached by means of a second wire to the suspension wire of the grenade. The cross wire also is attached to a spring or weight. When the cross wire is pulled the spring or weight snaps it back when the tension is removed, thus pulling out the suspension wire. The grenade falls down in its tube and is detonated by the driving-in of the firing pin. A flexible stake or sapling often has been used instead of the spring or weight.

Another frequently encountered arrangement has a grenade at each end of a string stretched between trees or stakes. The string is wrapped around nails in the trees or stakes in such a way that it will be pulled off if the string is tugged anywhere between

the mountings. When the string is pulled off the nails, the grenades fall and strike a stone or hard object directly beneath them. This drives in their pins and detonates them.

Various types of electrical ignition booby traps also have been found. A piece of bamboo sawed out at one end to resemble a clothespin has been widely used. Wires leading to a dry battery and explosive are taped to the outside edges of the clothespin prongs and connected with a nut and bolt inside the prongs of the pin. Pressure on the prongs causes the bolt and nut to touch, thus completing the circuit with the dry battery and the explosive. The latter is usually a bottle of picric acid in a shell case. Phonographs and radios have been wired as booby traps. Lifting the playing arms of the phonograph or turning the switch of the radio detonates the explosive.

In Burma large numbers of tin-can traps were found. A British grenade with its pin pulled out and the release handle held down was carefully inserted in a tin can, one end of which was attached to a trip wire. When the wire was pulled the can was pulled off away from the grenade; the release handle then

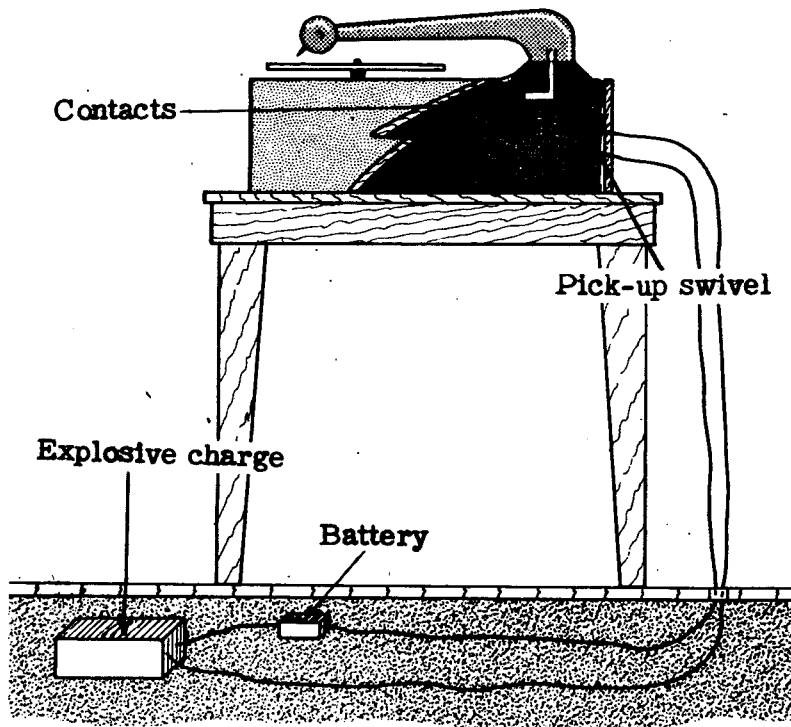

Figure 122. Phonograph booby trap.

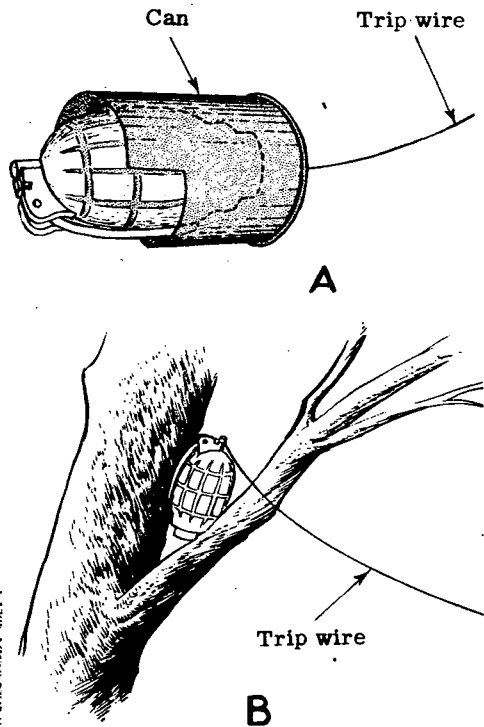

Figure 123. Tin-can type booby trap, using British grenade.

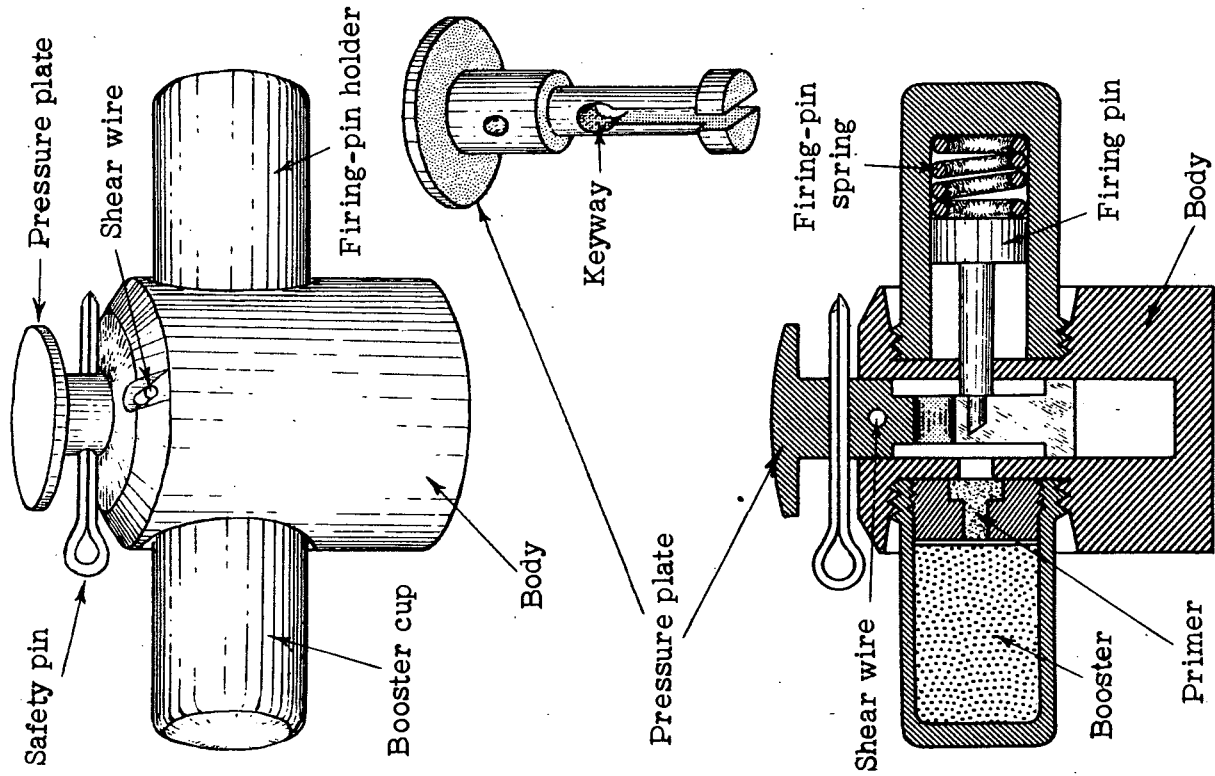

Figure 124. Firing device for booby trap.

sprang and caused detonation. Grenades also have been set in forks of trees in such a manner that the handle was held down. A pull on the attached trip cord dislodged the grenade and caused its detonation when the release handle snapped up into its firing position.

A firing device for booby traps has been found recently. Pressure of about 6 pounds on the pressure plate breaks the shear wire, permitting the plunger to go down into the body of the device. A hole in the plunger permits the firing pin to snap through it to activate the primer and detonator.

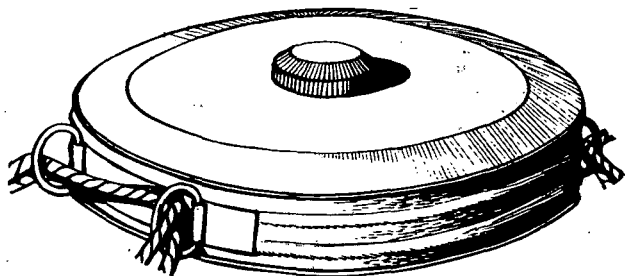

Figure 125. Tape-measure mine.

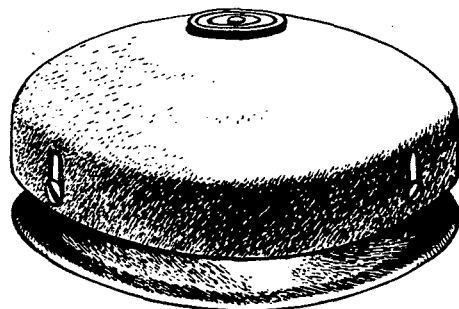

Figure 126. Mushroom-type mine.

Land Mines

The most common Japanese land mine is the Type 93, or "Tape-Measure Mine", so called because it resembles a rolled-up steel tape measure. The mine weighs about 3 pounds and is $6\frac{3}{4}$ inches in diameter and $1\frac{3}{4}$ inches thick. It is filled with 2 pounds of picric acid. In the center of its top is a bronze plug which covers the fuze. There are loops on the casing to permit suspension of the mine or drawing it across the path of a tank by means of an attached cord. Pressures of from 70 to 200 pounds will activate the

mine; the shear wire is adjusted to vary the pressure at which it will be detonated. There is a safety cap in the upper end of the firing pin. These mines usually are laid in patterns of diagonal rows 30 inches apart.

A leading Japanese antitank mine is the magnetized armor-piercing type. This contains eight sections of TNT wrapped in wax paper and held in a circular canvas bag. Four magnets are attached to the outside of the bag. To prepare the mine for firing, a wooden plug is pulled out and a percussion igniter of the delay type inserted. The mine then is thrust against the tank to which it adheres by action of the magnets. The safety pin is withdrawn and the firing pin is depressed, activating the igniter and causing detonation within 4 to 5 seconds.

One of the most recently introduced land mines is the so-called yardstick type. It is 3 feet long and is made up of four fused units in a smooth, flattened-steel casing with an oval cross section. The tube contains eight $\frac{3}{4}$ -pound blocks of picric acid. It is detonated by pressures of from 6 to 10.6 pounds.

It should also be borne in mind that the Japanese captured a large number of the Dutch mushroom-

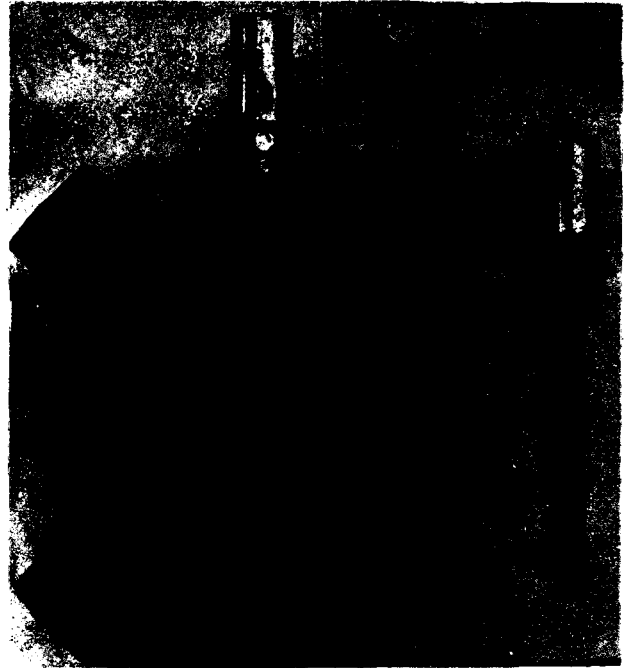

Figure 127. Japanese magnetic mine.

**JAPANESE
ANTI-INVASION MINE**



Figure 128. Japanese anti-invasion mine.

type land mines, and these may be encountered in any theater of operations. The mine is a disc $8\frac{1}{4}$ inches in diameter and $3\frac{1}{4}$ inches thick, with a dome-like cover held off the striker by a light spring. Total weight of the mine is $9\frac{1}{4}$ pounds, $5\frac{1}{4}$ pounds of which is the weight of the TNT. Fifty pounds pressure will be sufficient to press the cover down upon the striker to detonate the mine.

When landings were made on the beach at Tarawa, Gilbert Islands, a number of anti-invasion mines were found arranged in a single straight row, parallel to and 50 yards from the highwater mark on the beach. These mines are hemispherical and are of all-welded construction. There are two handles and two horns, and a central opening in the top which contains the booster and safety switch. The horns contain vials of acid. When either horn is bent, the acid vial is broken, permitting the acid to drop upon the plates of a small battery which has a zinc cathode and a copper anode. A current of sufficient amperage is generated to explode the charge which is in the bottom chamber of the mine.